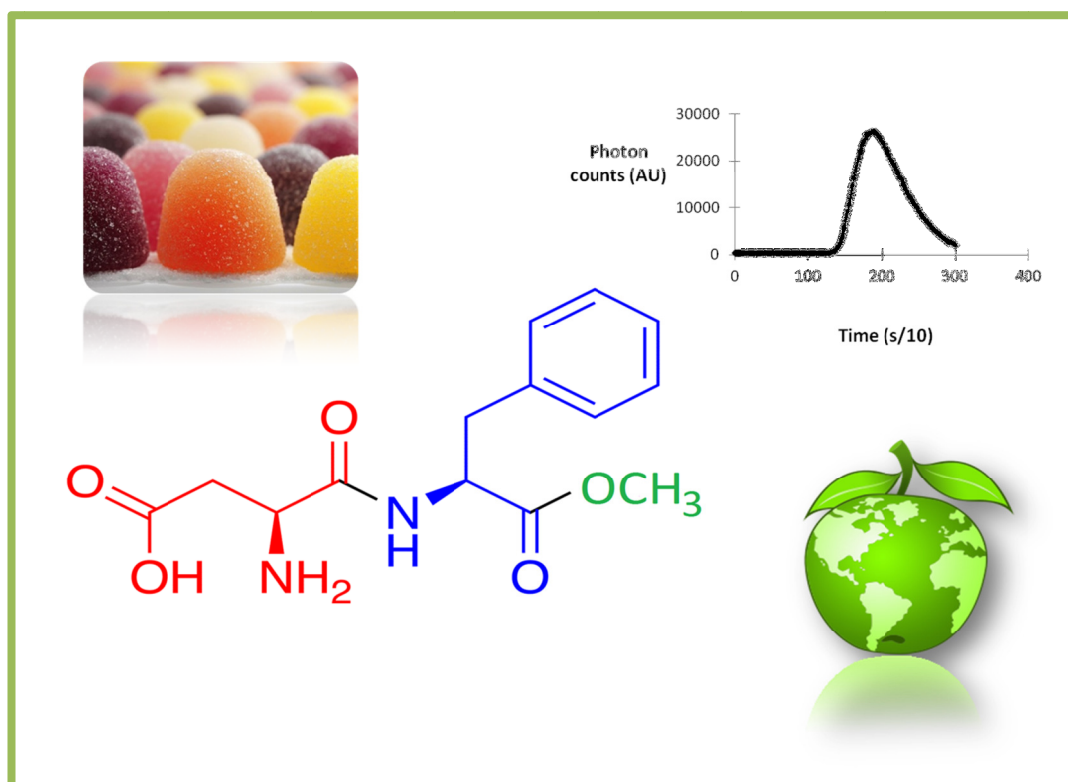


PhD Thesis

Lucyna Łekawska-Andrinopoulou

## Green methods for methyl esters determination in foodstuffs

Supervisor: Prof. Constantinos A. Georgiou



Chemistry Laboratory

Department of Food Science and Human Nutrition

Agricultural University of Athens

Athens 2013



Cover images come from the following sources:

- <http://thechalkboardmag.com/toxic-timeout-aspartame> ,
- <http://dchoos.org/events/farmer%E2%80%99s-market-sustainable-food-speaker-event/> ,
- Chemiluminescent measurement readout from this work.

The chemical formula of aspartame is used.

## ΔΙΔΑΚΤΟΡΙΚΗ ΔΙΑΤΡΙΒΗ

Green methods for methyl esters determination in foodstuffs

Lucyna Łekawska-Andrinopoulou

ΕΠΙΒΛΕΠΩΝ ΚΑΘΗΓΗΤΗΣ: Κωνσταντίνος Α. Γεωργίου

### ΤΡΙΜΕΛΗΣ ΣΥΜΒΟΥΛΕΥΤΙΚΗ ΕΠΙΤΡΟΠΗ

Κωνσταντίνος Γεωργίου

Επιβλέπων, Καθηγητής ΓΠΑ

Μιχαήλ Κωμαίτης

Καθηγητής ΓΠΑ

Μόσχος Πολυσιού

Καθηγητής ΓΠΑ

### ΕΠΤΑΜΕΛΗΣ ΕΞΕΤΑΣΤΙΚΗ ΕΠΙΤΡΟΠΗ

Κωνσταντίνος Γεωργίου

Καθηγητής ΓΠΑ

Μιχαήλ Κωμαίτης

Καθηγητής ΓΠΑ

Μόσχος Πολυσιού

Καθηγητής ΓΠΑ

Σέρκος Χαρουτουιάν

Καθηγητής ΓΠΑ

Δημήτριος Γεωργακόπουλος

Αναπληρωτής Καθηγητής ΓΠΑ

Αναστάσιος Οικονόμου

Αναπληρωτής Καθηγητής ΕΚΠΑ

Πέτρος Ταραντίλης

Αναπληρωτής Καθηγητής ΓΠΑ

ΑΘΗΝΑ 2013





To my parents  
Liliana and Tomasz



## **Preface**

This PhD thesis aims to fulfill requirements for PhD degree at the Department of Food Science and Human Nutrition at the Agricultural University of Athens. The research leading to the results presented in this PhD thesis has received funding from the [European Community's] Seventh Framework Program [FP7/2007-2013] under Grant agreement No. 238084 as a part of the EU-ITN LEANGREENFOOD network project.

The thesis is based partially on work published in scientific journals and conference proceedings presented on pages ix and x.

I would like to thank my supervisor Prof. Georgiou for his support, daily contact and patience and Prof. Georgakopoulos for co-supervising my work. I would like to thank both of them for making it possible for me to be a part of the LGF project.

I would like to thank all the people who have worked with me, especially Kata Trifković for performing kinetic aspartame determination experiments, Milana Zarić for working with pectin methylesterase activity assay and Prof. Yialouris for providing Visual Basic program for data treatment. Special thanks to Efstathios Vasiliou who was dealing with the software and was always there when help was needed. I would like to thank Jelena Radević who was involved in aspartame determination experiments and Mahsa Naghshineh for providing data on the degree of esterification and galacturonic acid content of pectin samples. I would like to thank Prof. Mousdis for making it possible for me to perform some experiments at the National Hellenic Research Foundation.

Special thanks for the team of Chemistry Laboratory for kindness, help and smiles. I would also like to thank LGF project group for support and fruitful meetings.



## **Abstract**

In this thesis development of novel, green methods for methyl esters in foodstuffs is described. Methods are based on enzymatic reactions and fluidics. Study focuses on two methyl esters: pectin methyl ester and aspartame, a methyl ester of aspartic acid/phenylalanine dipeptide.

Pectin and aspartame are enzymatically hydrolysed by pectin methylesterase or  $\alpha$ -chymotrypsin, respectively. Methanol is released and quantified. Several methanol determination methods have been tested, with the method with 4-AAP and phenol showing the best prospects for automation. Method was optimized and its robustness was investigated. Ascorbic acid interference removal with 4-hydroxy TEMPO was tested.

Development of two automated methods for methyl esters determination is described: spectrophotometric pectin methyl esters determination and chemiluminescent aspartame determination. The method for pectin methyl esters is the first work on pectin analysis through flow injection. Detection limit down to 1.47 mM was achieved at the analysis rate of 7 samples  $\text{h}^{-1}$ . The method provides identical results with manual off-line method. The development of the aspartame analyzer was preceded by the development of a spectrophotometric method, which showed good results in samples containing higher aspartame concentrations than expected in beverages. In order to improve method for possible application in beverages chemiluminescent detection was selected for the automated method. The chemistry from kinetic study was modified to accommodate luminol chemiluminescent detection and optimization of the system was performed. Several manifolds were constructed and the effect of following parameters was tested: flow rate, mixing coils length, location and number, preincubation time, alcohol oxidase concentration, use of separate solutions of AOX and HRP. 0.8 ml/min/line flow rate in combination with one 100 cm mixing coil, 60 s preincubation and use of separated solutions of AOX and HRP resulted in sufficient sensitivity that allowed for construction of a calibration curve within the range of aspartame concentration found in diet drinks.

Additionally, following side projects related to the main topic of the study are described: development of PME activity assay and galacturonic acid determination.

Scientific region: Analytical Chemistry.

**Key words:** methyl esters, sustainability, flow injection, pectin, aspartame, green chemistry



## ΠΕΡΙΛΗΨΗ

Αυτή η διδακτορική διατριβή περιγράφει την ανάπτυξη νέων, πράσινων μεθόδων για τον προσδιορισμό μεθυλεστέρων στα τρόφιμα. Οι μέθοδοι βασίζονται σε ενζυματικές αντιδράσεις και ρευστών. Η διατριβή επικεντρώνεται σε δύο μεθυλεστέρες: μεθυλεστέρας της πηκτίνης και ο ασπαρτάμη - ένας μεθυλεστέρας του ασπαρτικού οξέος / διπεπτιδίου της φαινυλαλανίνης.

Οι μέθοδοι που αναπτύχθηκαν βασίζονται στην ενζυμική υδρόλυση προς μεθανόλη. Το στάδιο της υδρόλυσης ακολουθείται από προσδιορισμό μεθανόλης. Διάφοροι μέθοδοι προσδιορισμού μεθανόλης έχουν αξιολογηθεί, με 4-αμινοαντιπυρίνη (4-AAP) και φαινόλη η πιο κατάλληλο για αυτοματοποίηση. Η μέθοδος αυτή βελτιστοποιήθηκε για την συγκέντρωση οξειδάσης της αλκοόλης. Αξιολογήθηκε η επίδραση του pH και της θερμοκρασίας, καθώς και επίσης η μακροπρόθεσμη σταθερότητα του διαλύματος εργασίας των ενζύμων. Εξάλειψη της επίδρασης του ασορβικού οξέως με χρήση 4-υδροξυ-TEMPO εξετάστηκε.

Προσδιορισμό δύο αυτοματοποιημένων μεθόδων για προσδιορισμό μεθυλεστέρων περιγράφεται: αναλυτή φασματοφωτομετρική μέθοδο για μεθυλεστέρες της πηκτίνης και χημειοφωταύγειας για προσδιορισμό ασπαρτάμης. Η μέθοδος για μεθυλεστέρες είναι η πρώτη που αναπτύχθηκε για τον ποιοτικό έλεγχο της πηκτίνης με τεχνολογίες ροής. Επιτεύχθηκε όριο ανίχνευσης 1.47 mM με ταχύτητα ανάλυσης 7 h<sup>-1</sup> ενώ τα αποτελέσματα είναι ισοδύναμα με αυτά που πετυχαίνονται με την συνήθως χρησιμοποιούμενη μη αυτοματοποιημένη μέθοδο όπως δείχνει σύγκριση με την δοκιμασία *t*. Αρχικό στάδιο αναλυτή ροής για προσδιορισμό ασπαρτάμης είναι η ανάπτυξη κινητικής μεθόδου προσδιορισμού ασπαρτάμης που δείχνει καλά αποτελέσματα σε δείγματα νερού που περιέχει υψηλές συγκεντρώσεις ασπαρτάμης. Όπως έδειξε η προκαταρκτική μελέτη, για την ανάπτυξη της αυτοματοποιημένης μεθόδου επιλέχθηκε η χημειοφωταύγεια ως τεχνική ανίχνευσης. Διάφορα συστήματα διαύλων κατασκευάστηκαν για μελέτη των κάτωθι παραμέτρων: ταχύτητα ροής, μήκος, θέση και αριθμός των σπειραμάτων αντίδρασης, χρόνος προεπάσης, επίδραση της συγκέντρωσης της οξειδάσης της αλκοόλης και χρήσης της με χωριστό διάλυμα. Ταχύτητες ροής 0,8 ml/min/διάυλο σε συνδιασμό με ένα σπείραμα 100 cm εκατοστά, προεπάση 60 s και διαχωρισμό των ενζύμων οδήγησαν σε αναλυτικό σήμα που επέτρεψε την κατασκευή καμπύλης βαθμονόμησης στο εύρος των συγκεντρώσεων ασπαρτάμης που ενδιαφέρει την ανάλυση τροφίμων.

Επιπλέον, οι ακόλουθες ανεπιθύμητες έργα περιγράφεται: ανάπτυξη προσδιορισμού της δραστηριότητας της μεθυλεστεράσης της πηκτίνης και προσδιορισμό γαλακτουρονικό οξύ.

Επιστημονική περιοχή: Αναλυτική Χημεία. **Λέξεις κλειδιά:** μεθυλεστέρες, βιωσιμότητα, ένεση ροής, πηκτίνη, ασπαρτάμη, πράσινη χημεία





# Contents

Preface .....	i
Abstract .....	iii
ΠΕΡΙΛΗΨΗ .....	v
Conference Proceedings .....	ix
Publications .....	x
List of reactions .....	xi
Theoretical part.....	1
1. Introduction .....	1
1.1. Esters .....	2
1.1.1. Pectin and pectin methyl esters .....	3
1.1.2. Aspartame.....	5
1.1.3. Methyl esters determination .....	6
2. Flow injection.....	8
2.1. FI principles.....	9
2.2. Automation step by step .....	10
2.3. Flow injection in food analysis.....	11
3. Kinetic methods of analysis.....	13
3.1. Kinetic methanol determination .....	13
3.2. Kinetic galacturonic acid determination.....	16
3.3. Enzymes .....	17
4. Detection methods.....	19
4.1. Spectrophotometry .....	19
4.2. Chemiluminescence.....	20
Experimental part .....	22
5. Methanol determination.....	22
5.1. Hydrogen peroxide measurement with ABTS.....	22
5.2. Hydrogen peroxide measurement with 4-AAP/phenol.....	24
5.2.1. Removal of ascorbic acid interference .....	29
5.2.2. Relative response: methanol/ethanol .....	34
5.2.3. PME assay .....	35
5.2.4. Final ABTS & 4-AAP/phenol methods evaluation .....	44
5.3. Insight into the use of formaldehyde .....	45

6.	Flow analyzer for pectin methyl esters.....	47
7.	Flow analyzer for aspartame determination .....	62
7.1.	Kinetic aspartame determination.....	62
7.2.	Analyzer development.....	69
8.	Chemistries for potential automation of galacturonic acid determination.....	89
8.1.	Galacturonic acid odixation with iodine.....	89
8.2.	Galacturonic acid oxidation with cerium (IV).....	93
	Conclusions and further research perspectives.....	102
	Abbreviations .....	106
	Annex 1: Spectra .....	109
	Annex 2: GILSON Minipuls 3 calibration data.....	113
	Annex 3: Determination of PME activity in Pectinex 3 XL.....	114
	Bibliography.....	115

## Conference Proceedings

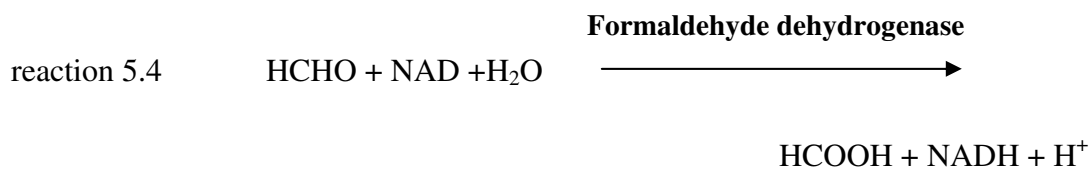
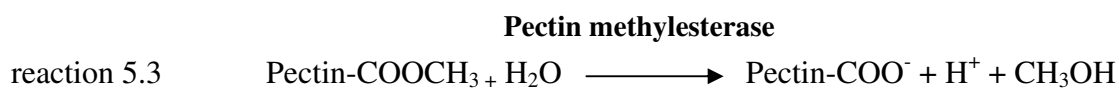
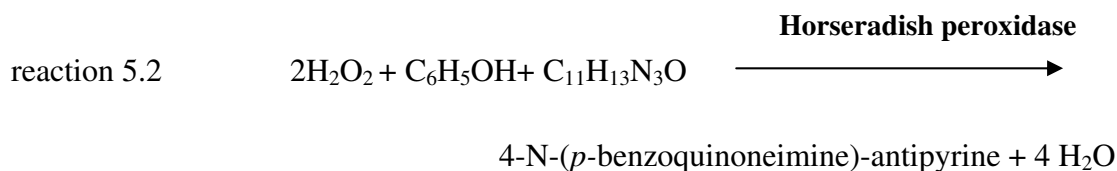
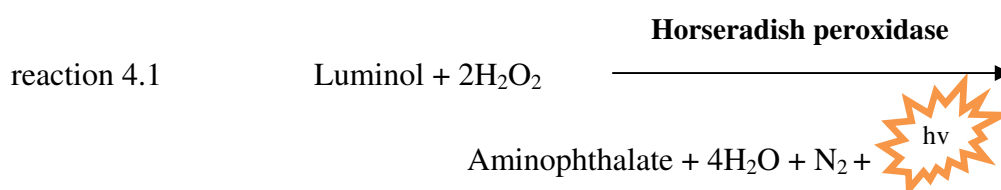
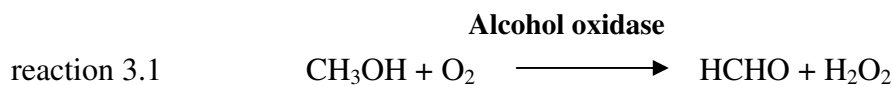
- Łękawska L., Vasiliou E. G., Georgakopoulos D. G., Georgiou C. A., Flow injection analyzers for sustainable pectin analysis. *12<sup>th</sup> International Conference on Flow Analysis, Book of abstracts p. 152, Thessaloniki, Greece, 23-28 September 2012.*
- Łękawska L., Georgakopoulos D. G., Georgiou C. A., Green Chemistry Technologies for Pectin Analysis. *Third International Symposium on Green Chemistry for Environment, Health and Development, Book of abstracts p. 63, Skiathos, Greece, 3-5 October 2012.*
- Łękawska – Andrinopoulou L., Vasiliou E. G., Georgakopoulos D. G., Georgiou C. A. Towards green food quality control. Fluidic automation technologies. *Enzymes in Sustainable Food Production. A Lean Green Food Approach, Book of abstracts p. 25, Halkidiki, Greece, 11-13 June 2013.*
- Trifković K. T., Łękawska L., Bugarski B. M., Georgiou C. A. Enzymatic spectrophotometric reaction rate determination of aspartame in carbonated beverages and sweeteners. *III International congress “Engineering, Environment and Materials in Processing Industry”, Conference Proceedings, p. 592-598, Jahorina, Bosnia and Herzegovina, March 4-6, 2013.*
- Zarić M., Łękawska L., Bugarski B. M., Georgiou C.A. Pectin methylesterase activity assay. *III International congress “Engineering, Environment and Materials in Processing Industry”, Conference Proceedings, p. 645-648, Jahorina, Bosnia and Herzegovina, March 4-6, 2013.*

## **Publications**

- Łękawska-Andrinopoulou L., Vasiliou E. G., Georgakopoulos D. G., Yialouris C. P., Georgiou C. A. Rapid enzymatic method for pectin methyl esters determination, *under review, Journal of Analytical Methods in Chemistry*
- Trifković K. T., Łękawska-Andrinopoulou L., Bugarski B. M., Georgiou C. A. Enzymatic spectrophotometric reaction rate determination of aspartame, *under review, Chemical Industry*

## List of reactions

Reactions are numbered as in the text.





# **Theoretical part**

## **1. Introduction**

Concern about the natural environment is noticeable trend in all aspects of life in nowadays modern societies. Growing global shortages of natural resources and on the other hand increasing demand for food in the world scale call for sustainable and at the same time extremely efficient food production systems. During the last 70 years food industry has gone through a major transition in some parts of the world. From assuring sufficient amount of safe food to big number of people in the period after the Second World War to satisfying the individual needs of often demanding customers nowadays, who are also often interested in the influence the food production process has on the environment. At the same time constant population expansion in developing countries poses a major threat of running out of supplies. Lower resource consumption and waste generation, re-use of resources, utilization of by-products, greener and more efficient production processes and at the same time assuring satisfactory product quality for the growing number of demanding consumers are the challenges faced by the food industry of today. It is crucial for the food sector to develop new, state of the art processes that are meeting these global challenges.

In the quest for sustainable food production systems it is essential to assure that all levels of food production systems are as environmentally friendly as possible. Food analysis, an integral part of any food production system is one of them. Green methods for food quality control are an inherent element of nowadays food production procedures. At the same time food analytical methods have to comply with demanding national and international standards. Fast, real-time, reliable and environmentally friendly analytical methods that are able to monitor processes on-line are technologies that food providers are looking for nowadays.

Food analysis methods presented in this thesis are mostly based on flow techniques. Flow methods are well established branch of analytical chemistry. The main principle is that sample is injected into the flowing stream of reagents. The mixture reaches the flow-through detector where the analytical signal is recorded. This approach offers a range of advantages where automation and increased precision are only a few of them. Attributable to minimal sample and reagent consumption and low waste generation, sustainability is inherent part of flow methods. Sustainability is further enhanced



when harsh chemicals are replaced by enzymes, natural biocatalysts. In such way chemical waste is avoided and milder, lean green technologies are obtained. The main topic of this thesis is the development of novel, green methods based on enzymes for methyl esters determination in foodstuffs. The key target analytes are pectin methyl esters and aspartame i.e. methyl ester of aspartic acid/phenylalanine dipeptide.

## 1.1. Esters

Esters are created in a reaction of oxoacid with alcohol, phenol, heteroarenol, or enol (McNaught and Wilkinson, 1997). The general formula of an ester is  $\text{RCOOR}'$  where R and R' are alkyl group.

Esters are widespread in nature. Some examples are fatty acid esters of glycerol present in plant oils and animal fats (IUPAC-IUB Commission on Biochemical Nomenclature, 1976). Mixtures of different low molecular esters are the main source of pleasant aromas of flowers and fruits. The main esters responsible for common fragrances are presented in Table 1.1.

*Table 1.1. Some common natural esters and corresponding fragrances (Denniston et al., 2004).*

<b>Ester</b>	<b>Chemical formula</b>	<b>Fragrance</b>
<b>Isoamyl acetate</b>	$\text{C}_7\text{H}_{14}\text{O}_2$	banana
<b>Octyl acetate</b>	$\text{C}_{10}\text{H}_{20}\text{O}_2$	orange
<b>Methyl butyrate</b>	$\text{C}_5\text{H}_{10}\text{O}_2$	apple
<b>Ethyl butyrate</b>	$\text{C}_6\text{H}_{12}\text{O}_2$	pineapple
<b>Pentyl butyrate</b>	$\text{C}_9\text{H}_{18}\text{O}_2$	apricot
<b>Methyl thiobutanoate</b>	$\text{C}_5\text{H}_{10}\text{OS}$	strawberry

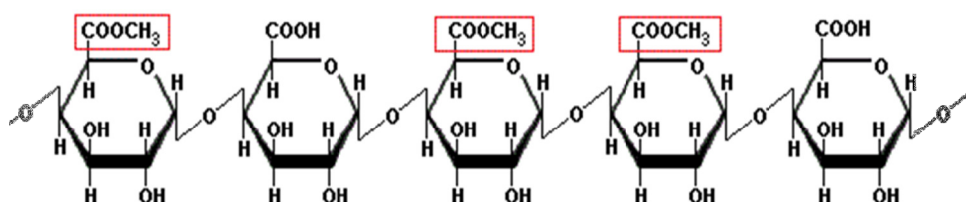
Due to their unusual properties many esters are of commercial importance for cosmetics and food flavorings sectors where certain flavors are intended to be

mimicked. Other important function of esters in nature is the formation of DNA backbone by phosphodiester (Lodish et al., 2000).

This thesis focuses on the determination methods for methyl esters commonly present in foodstuffs. Two methyl esters have been selected; one of them being natural ester: pectin methyl ester and the other aspartame - artificial sweetener, a methyl ester of aspartic acid/phenylalanine dipeptide. Development of the methods for their determination is presented in this thesis.

### 1.1.1. Pectin and pectin methyl esters

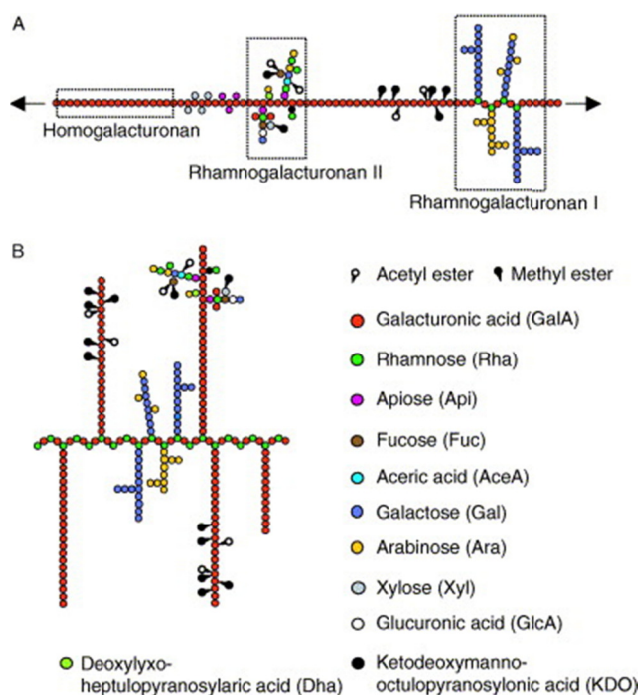
Pectin, a natural polysaccharide present in the cell walls of higher plants, is an important compound for food and pharma industries. The importance of the compound is related to its unique properties and the fact that it is biodegradable natural additive. The main raw materials from which commercial pectin is extracted are agricultural by-products i.e. citrus peel and apple pomace. The major applications of pectin in food products rely on its gelling and stabilizing properties. Pectin is commonly used for production of foodstuffs like jams, jellies, marmalades as a gelling agent but also in acidified milk drinks, beverages or confections as stabilizer (BeMiller, 2007). The gelling properties of pectin are a consequence of its structure. It has to be kept in mind that name 'pectin' relates to a group of polysaccharides of diverse structures, with three key ones being: homogalacturonan (HG), rhamnogalacturonan-I (RG-I) and rhamnogalacturonan II (RG-II). HG is composed of  $\alpha$ -(1-4)-linked D-galacturonic acid some of them being esterified with methanol (Figure 1.1) or acetylated.



**Figure 1.1.** Methylesterified polygalacturonic acid (Guan et al., 2011 - modified)

RG-1 has a disaccharide backbone (1→2)- $\alpha$ -L-rhamnose-(1→4)- $\alpha$ -D-galacturonic acid with glycan side chains. RG-II is a structure with HG backbone and diverse side chains attached. The common characteristic of all three domains is high content of

galacturonic acid (Ridley et al., 2001; Willats et al., 2001, 2006.). The alternative structure of pectin (Figure 1.2, B) presented by Vincken et al., 2003 treats HG as a side-chain of RG-1. Two representations of suggested pectin structures are presented in Figure 1.2.



**Figure 1.2.** Schematic representation of pectin *A. conventional, B. alternative* (Willats et al., 2006)

Degree of pectin methylation (DM), by some authors called degree of methyl esterification, is defined as the percentage of methyl esterified carboxyl groups in relation to all carboxyl groups. DM 50 % is considered as a borderline between low-methoxyl (LM) and high-methoxyl (HM) pectins. DM influences the conditions that should be applied for pectin to form a gel. High-methoxyl pectins gel in the presence of sufficient amount of sugar and acid. Low-methoxyl pectins require divalent cations to form a gel structure. The ability of LM pectins to gel without sugar makes them especially suitable for dietetic i.e. low sugar foodstuffs (BeMiller, 2007). The degree of methylation is related to the setting times of pectins (Thibault and Ralet, 2001). Based on the setting times, the most suitable pectin application can be chosen. For example rapidly setting pectins are perfectly suited for jams and marmalades. In contrast, slowly setting pectins are especially useful for production of jellies, when

additional time for elimination of air bubbles before gelling is needed (BeMiller, 2007).

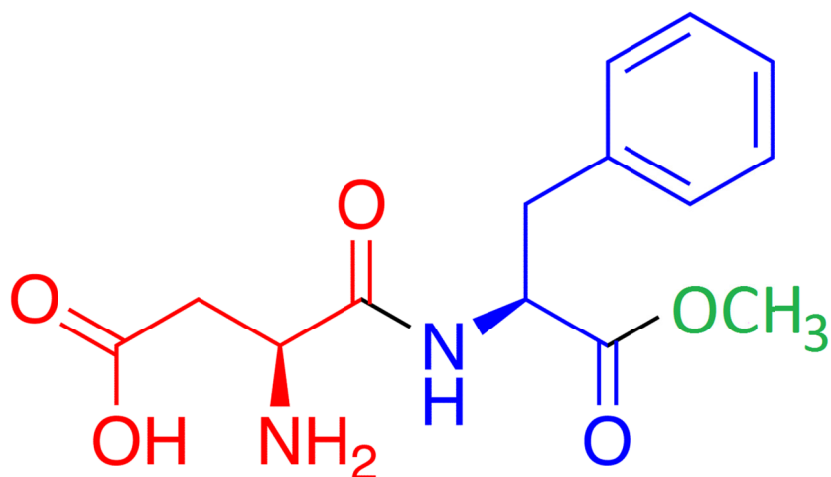
Pectins are used in the pharmaceutical industry for drug delivery systems (Liu et al., 2007). Their applications greatly depend on the degree of methylation, e.g. LM pectins are used in nasal preparations due to their ability to form gels in the presence of calcium cations (Morris et al., 2010). DM also influences the drug release time from pectin-based matrix tablets when calcium formulations are used (Sungthongjeen et al., 2004)

As presented in the above paragraph, degree of methylation greatly influences the application of pectin. This is the reason why rapid and reliable methods for fast quantification of pectin methyl esters are of major interest and importance.

### **1.1.2. Aspartame**

Aspartame is an artificial, low-calorie sweetener of relative sweetness 200 compared to sucrose (Coultate, 1996). It is used in diverse types of drinks, yoghurts, chewing gums, pharmaceutical products and as tabletop sweetener by consumers who either want to avoid sugar or are forced to do so by their medical condition. Aspartame is codified as E951 in the EU. Due to constantly growing demand for diet products there is a continuous interest in aspartame sweetened drinks and foodstuffs. Aspartame products are sold all over the world. Supporting legislation exists in both Europe (Directive 94/35/EC on sweeteners for use in foodstuffs, 1994) and USA (Code of Federal Regulations Title 21, 1974). It needs to be however pointed out that its consumption for many remains a controversial issue due to a possible negative health effect (Tandel, 2011; Whitehouse et al., 2008). Therefore fast and accurate methods for aspartame determination are of special importance.

Aspartame is a methyl ester of aspartic acid/phenylalanine dipeptide (Figure 1. 3). It is composed of aspartic acid, phenylalanine and methanol, to which it breaks within digestive system after consumption.



*Figure 1.3. Methyl ester of aspartic acid/phenylalanine dipeptide. Following color code is used: red – aspartic acid, blue – phenylalanine, methanol – green.*

### 1.1.3. Methyl esters determination

Pectin methyl esters can be hydrolyzed either by alkaline hydrolysis or enzymatically by pectin methylesterase. Released methanol can be quantified by means of e.g. GC (Bartolome and Hoff, 1972; Savary and Nuñez, 2003) or with alcohol oxidase (Klavons and Bennett, 1986). When alcohol oxidase is used, the methanol content can be related to formaldehyde (Anthon and Barrett, 2004) or hydrogen peroxide concentration (Mangos and Haas, 1996). Other examples of methods for pectin degree of methylation include determination from the ratio of the methyl esters to the total uronic content (Voragen et al., 1986) or using FT-IR spectroscopy (Chatjigakis et al., 1998).

Flow-injection systems for methanol determination have been reported in the literature (Almuzara et al., 2002; Burfeind et al., 1996; de María et al., 1995; Förster et al., 1993; Sekine et al., 1993; Yue and Zhang, 2007). However, the use of flow-injection for pectin analysis remains unexplored. The application of flow-injection methods for pectin analysis offers novel, green technologies, which are in agreement with current sustainability trends. In this thesis pectin quality assessment through flow analysis is presented for the first time.

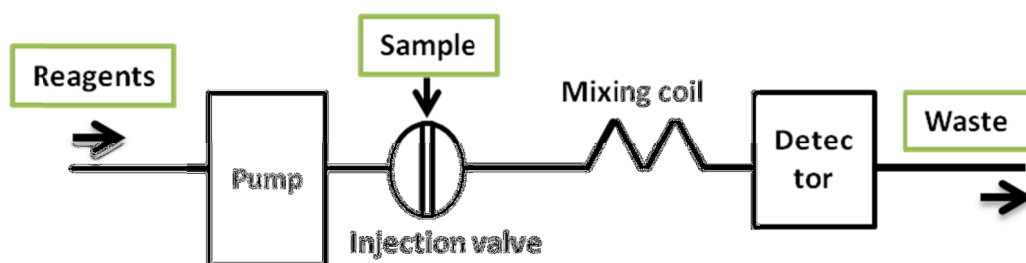
Increased popularity of aspartame within food industry has resulted in a big number of methods for its determination in recent years (Armenta et al., 2004; Lim et al., 2013; Stojkovic et al., 2013; Turak and Ozgur, 2013). Flow method for aspartame

determination described in this thesis is characterized by high sensitivity due to the use of chemiluminescent detection, increased precision as it is based on flow injection and simplicity with straightforward, user-friendly software.

Both aspartame and pectin determination methods presented in this thesis are based on the methylester structure of pectin and aspartame. In all developed methods first step is the enzymatic hydrolysis of pectin by means of pectin methylesterase or aspartame by  $\alpha$ -chymotrypsin. Methanol is released and enzymatically converted to formaldehyde and hydrogen peroxide, which are then quantified by means of different detection methods. Developed methods use different detection techniques. Spectrophotometry has been used for kinetic determinations of methanol and aspartame as well as for pectin methyl esters analyzer. Additionally, more sensitive, automated method for aspartame determination based on chemiluminescent determination was developed.

## 2. Flow injection

Flow injection (FI) is a well established branch of analytical chemistry. It was introduced in the seventies by Ruzicka and Hansen (Ruzicka and Hansen, 1975) and since then has found an application in vast number of chemical and biological assays. Flow injection analysis is based on automated methods in which sample is injected into the stream of flowing reagents (Figure 2.1) or water with reagents added downstream. These solutions are continuously propelled through the tubing by a peristaltic pump. Flow rates are regulated by adjusting peristaltic pump speed or varying internal diameter (I.D.) of the tubing.



*Figure 2.1. Flow-injection manifold.*

Frequently after sample injection the flowing stream merges with other reagent stream/streams. Injected sample mixes with the reagents within mixing coils and the reaction product reaches the flow-through detector. Various detection methods offering different sensitivities can be combined with flow methods e.g. chemiluminescence, spectrophotometry, bioluminescence, fluorimetry, etc. The analyzer is fully controlled by software with variable parameters.

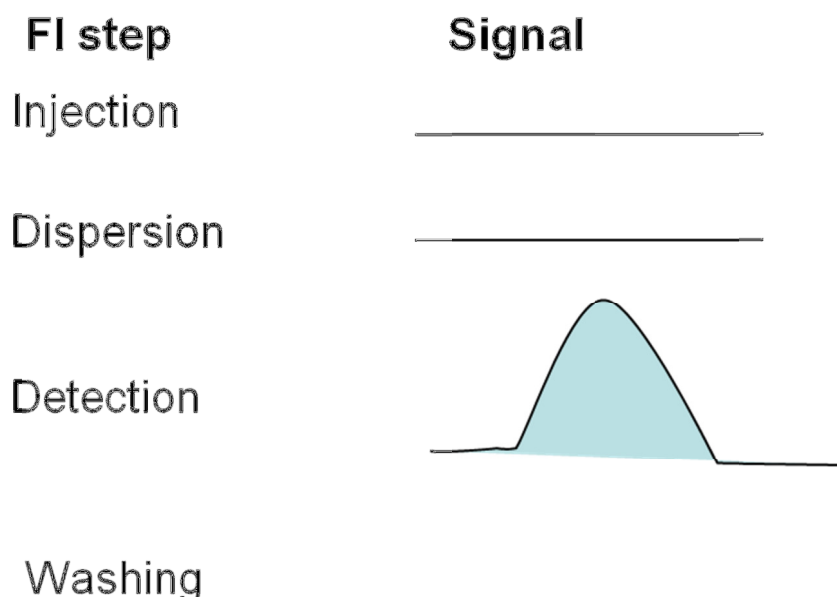
Flow injection methods are characterized by the following advantages:

- Automation,
- Increased precision and accuracy,
- High sample throughput,
- Cost reduction,
- Versatility,
- Minimized staff contact and exposure to potentially dangerous reagents,

- GREEN CHEMISTRY: minimal sample & reagent consumption, minimal waste generation; based on enzymes.

## 2.1. FI principles

The injection of the sample into the flowing stream of reagents results in formation of a zone. As the zone is travelling downstream, it is dispersed in the carrier stream and reacts with reagents. Product formation is being monitored by the detector producing analytical signal in a form of a peak (Georgiou et al., 2003) as presented on the Figure 2.2.



*Figure 2.2. Flow injection analysis steps and corresponding detector signal.*

Dispersion coefficient ( $D$ ) is an important parameter in flow analysis. It is defined as ratio of the sample concentration before ( $C^0$ ) and after ( $C$ ) injection/dispersion, where  $1 < D < 3$  is considered limited dispersion,  $3 < D < 10$  medium and  $D > 10$  large dispersion. Dispersion coefficient is usually measured by injection of a dye (e.g. phenolophtalein) into the carrier stream and comparison of the signal before and after the injection/dispersion (Ruzicka, 1988). Dispersion depends on the manifold parameters, like mixing coil length, flow rates, internal diameter of the tubing, sample volume, etc and therefore can be regulated by altering those parameters.



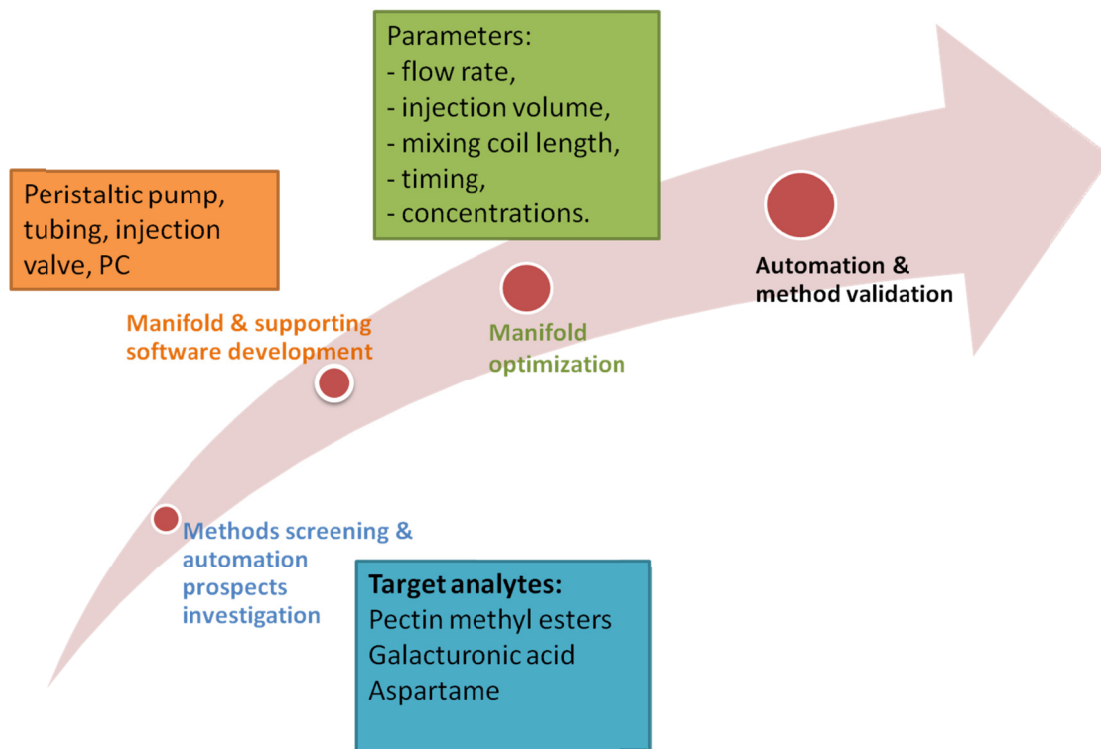
In reverse flow injection (rFI) it is the reagent that is injected into the carrier stream - the sample. rFI is a special approach in flow analysis that comes along with a variety of advantages, minimization of reagent consumption being the most common reason for choosing rFI mode. rFI is of interest when expensive reagents, like enzymes are used but also and when the sample is in abundance, e.g. when water is being analysed (Mansour and Danielson, 2012). It was demonstrated that if both sample and reagent are injected into the carrier stream up to 91 % of the reagent can be conserved in comparison to the standard mode (Bergamin F et al., 1978). Moreover, rFI offers increased sensitivity. The sample is not injected and therefore there is no significant dispersion of the sample, improving sensitivity of the measurement. The limitations of rFI are related to sample throughput as it might be necessary to stop the system in order to change the sample or even to employ washing solution between the measurements. Nevertheless since introduction of rFI in 1978 the number of publications using this approach is constantly increasing (Mansour and Danielson, 2012).

## **2.2. Automation step by step**

Careful methods screening and automation prospects investigation is the first step of every automation process (Figure 2.3). First, methods are thoroughly studied and selected as possible candidates for automation based on the current needs. Another aspect taken into account is the level of automation difficulty. Although nowadays virtually any method could be automated, fast methods which do not require high temperatures are the most trouble-free and therefore attractive. Target analytes taken into account in the scope of this thesis included methanol, pectin methyl esters, galacturonic acid and aspartame. The prospects of automation of selected methods for determination of target analytes of interest were assessed by performing manual laboratory experiments described in Chapters 5, 7.1, and 8 of this thesis.

The next step after methods screening and automation prospects investigation is manifold development. The peristaltic pump and injection valve are connected by tubing and supporting software is developed. The software controls peristaltic pump and injection valve and acquires data from the detector. Subsequently manifold optimization is performed. The aim of the optimization is to obtain highest possible sensitivity and sample throughput, while aiming at the lowest possible analysis time

and reagents consumption. Commonly optimized parameters include flow rate, injection volume, mixing coil lengths, timing and concentrations. The final step is to validate the developed method by comparing results with a standard method.



*Figure 2.3. Automation step by step.*

### 2.3. Flow injection in food analysis

Food quality and safety are important aspects of everyday life that are widely standardized by diverse regulations<sup>1,2,3</sup>. Expanding legislation on national level together with internal companies' regulations, resulting from the will to assure highest possible quality, cause that the number of parameters that have to be analysed is increasing. At the same time some of the substances to be detected are present in the

<sup>1</sup> Regulation (EC) No 1334/2008 of the European Parliament and of the Council of 16 December 2008 on flavourings and certain food ingredients with flavouring properties for use in and on foods and amending Council Regulation (EEC) No 1601/91, Regulations (EC) No 2232/96 and (EC) No 110/2008 and Directive 2000/13/EC.

<sup>2</sup> Regulation (EC) No 178/2002 of the European Parliament and of the Council of 28 January 2002 laying down the general principles and requirements of food law, establishing the European Food Safety Authority and laying down procedures in matters of food safety.

<sup>3</sup> Significant Amendments to the FD&C Act - Food Quality Protection Act of 1996.

foodstuffs in minute concentrations requiring methods of increased sensitivity (Tóth et al., 2008). Simultaneously, growing sustainability trends within the food sector and increasing consumer awareness urge the need for environmentally friendly methods. Those are the challenges that many food companies/food providers are facing nowadays. That is why need for fast, sensitive, inexpensive analytical methods for food analysis, which at the same time would be in accordance with sustainability rules, has arisen. Flow methods fulfill all those requirements additionally offering extra advantages appreciated by the food sector. The biological origin of food samples often results in non-homogeneity, sample color or turbidity making the analysis more difficult, often requiring advanced pretreatment. Methods like sample digestion, microwave pretreatment, UV or ultrasound radiation as well as separation techniques have been since many years efficiently merged with flow systems (Tóth et al., 2008). By using kinetic methods of analysis and multiple dilutions flow methods offer solutions to problems like sample color, normally causing problems in spectroscopic detection, or background signal. Also interferences are easily eliminated in kinetic methods of analysis.

### **3. Kinetic methods of analysis**

In kinetic methods of analysis, the analytical compound concentration is proportional to the initial reaction rate i.e. the reaction speed is the analytical signal. This comes along with a range of advantages offered by kinetic methods over end point methods in which amount of final product is measured (Vasilarou and Georgiou, 2000):

- ➔ Kinetic methods are fast. There is no need to wait for the reaction to be completed,
- ➔ Interferences from slow reactions are eliminated. Fast reacting interferences are removed by preincubation during which interfering compounds are consumed,
- ➔ In the kinetic methods background signal does not interfere as in the end-point methods.

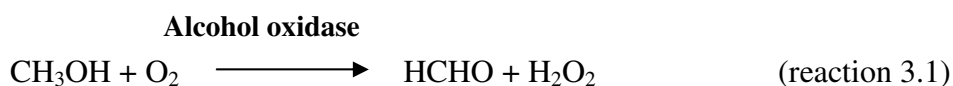
In kinetic methods of analysis pseudo-first order kinetics are used so that the measured reaction rate depends only on the concentration of the target analyte. It has to be kept in mind, that only a part of the signal is measured. This might result in a lower sensitivity in comparison to the end-point methods. Additionally, to obtain reliable results with kinetic methods of analysis it is necessary to control the conditions of the reaction such as temperature, pH, etc. (Vasilarou and Georgiou, 2000). This is of special importance in the systems where enzymes are used as catalysts. The accuracy of the measurement of the initial reaction rate is strongly dependent on the skills of the person performing the experiment. This limitation can be eliminated through automation which greatly increases the precision. Automated methods are by nature kinetic. In order to adopt a method for automation, chemistry of the method has to be investigated thoroughly. In this chapter the methods showing potential for automation are described paving the way for automated methods presented in further chapters of this thesis. Within this thesis development of kinetic methods for methanol, aspartame and galacturonic acid determination is described.

#### **3.1. Kinetic methanol determination**

Methanol, the simplest alcohol, is toxic to humans. However low levels of methanol are normally found in urine (Sedivec et al., 1981), saliva (Larsson, 1965), blood

(Batterman and Franzblau, 1997; Lee et al., 1992; Osterloh et al., 1996) and exhaled air (Eriksen and Kulkarni, 1963; Hannemann et al., 2011) of healthy individuals. The most probable source of methanol is dietary exposure to alcoholic beverages, aspartame, dimethyl dicarbonate and metabolism of compounds containing methyl esters in their structure like fruits and vegetables (Clary, 2013). According to the U. S Food and Drug Administration, safe daily intake of methanol is 7.1-8.4 mg/kg body weight (Food and Drug Administration, 1994). Since higher amounts of methanol are toxic to humans, methanol determination methods are of major importance. Moreover, methods for methanol determination can be applied for determination of methyl esters in foodstuffs i.e. pectin methyl esters or aspartame.

Methanol is often measured by GC (Lund et al., 1981; Mac Namara et al., 2005; Moaleş et al., 2011), HPLC (Sharma et al., 1991) or with enzymatic methods. Enzymatic methods for methanol determination are based on its oxidation by alcohol oxidase (EC 1.1.3.13, AOX), (reaction 3.1) (Klavons and Bennett, 1986).



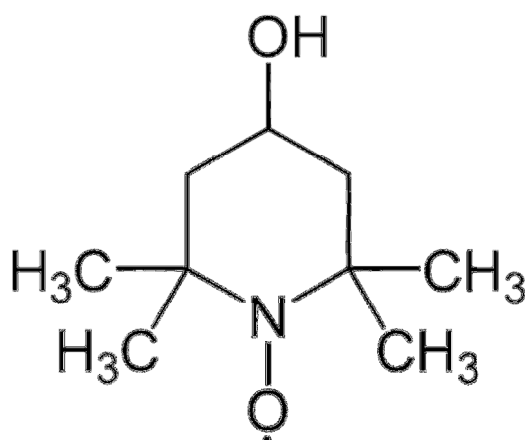
The next step is determination of methanol concentration by measuring hydrogen peroxide (Mangos and Haas, 1996) or formaldehyde (Anthon and Barrett, 2004) released in reaction 3.1, which concentrations are directly proportional to the concentration of methanol. Both ways of methanol determination, i.e. by hydrogen peroxide or formaldehyde measurements are presented in the Experimental part, Chapter 5 of the thesis. Following methods for methanol determination have been tested:

- through hydrogen peroxide measurement using ABTS,
- through hydrogen peroxide measurement using 4-aminoantipyrine (4-AAP) and phenol,
- through formaldehyde measurement.

Ascorbic acid (Vitamin C) that occurs commonly in foodstuffs interferes in peroxidase catalyzed assays, like the one with ABTS and 4-AAP/phenol. Ascorbic acid consumes hydrogen peroxide (reaction 3.2) that results in negative errors.



In kinetic methods of analysis low amounts of interfering substances can be removed by short preincubation with enzyme working solution, during which interfering substance is consumed (Vasilarou and Georgiou, 2000). However, if interferant concentration is higher than the analyte, this approach is potentially not sufficient. Ascorbic acid can be easily removed by using ascorbate oxidase (EC 1.10.3.3). However, to avoid addition of the third enzyme into the analytical system, 4-hydroxy TEMPO (Figure 3.1) was used as ascorbic acid quencher.



*Figure 3.1. 4-hydroxy-TEMPO.*

Use of 4-hydroxy-TEMPO has been reported for removing the ascorbic acid interference in clinical samples (Kayamori et al., 2000). 4-hydroxy TEMPO is a free radical that removes ascorbic acid interference by transforming it to dehydroascorbic acid, the oxidized form of ascorbic acid (Shiga et al., 1997).

### **Pectin methylesterase activity assay**

Pectin methylesterase (EC 3.1.1.11) (PME) is a multifunctional cell-wall associated enzyme produced by plants and playing an important role in many development and growth process e.g. fruit ripening, pollen growth and germination. Additionally PME in plants is involved in defense mechanisms against pathogens as it is capable of modifying plant cell walls (Pelloux et al., 2007). On the other hand PME is also produced by bacteria and fungi, often plant pathogens, which use PME in the process of pathogen invasion ( Fries et al., 2007; Benoit et al., 2012). The mode of action of

PME depends on its source. Fungal PMEs act in a random fashion, while PMEs from plant tend to act in a blockwise manner due to their preference to act next to free carboxyl groups or at non-reducing end (Forster, 1988).

PME is one of the enzymes of industrial importance. Industrial applications include mainly juice, concentrates and wine production processes. PMEs used in industry are produced by microorganisms. Microorganisms are widely employed for production of enzymes in low-cost and environmentally friendly way (Sieiro et al., 2012). PME used together with other pectinases reduces juice cloudiness being result of natural pectin presence, increases the juice yield and facilitates pressing process (Aehle, 2007). PME action paves the way for action of other pectinases that act preferably on deesterified pectin.

PME belongs to a group of pectinases, enzymes hydrolysing degradation of pectin and pectic substances. The classification of pectinases is based on the substrate they act on and the mechanism on which the enzymatic reaction is based. PME together with pectin acetyltransferase (EC 3.1.1.6) belongs to the subgroup of esterases. Both enzymes act on pectin. PME catalyzes the hydrolysis of methoxy groups present at the 6-carboxyl group of the pectin backbone composed of the galacturonic acid residues i.e. galacturonan. The products of this hydrolysis reaction are pectic acid and methanol (Gummadi et al., 2007). Existing PME activity assays are typically based either on appearance of free carboxyl groups or appearance of free methanol. Measurements are usually performed by means of titration, pH indicators and colorimetric reagents (Hagerman and Austin, 1986; Maldonado et al., 1994; Vilarinho et al., 1993). Within this thesis application of the methanol determination method through hydrogen peroxide measurement using 4-aminoantipyrine (4-AAP)/phenol was tested for PME activity assay. Two different approaches were applied based on PME source.

### **3.2 Kinetic galacturonic acid determination**

D-galacturonic acid is the core element of pectin constituting approximately 70 % of a pectin molecule (Mohnen, 2008). Although galacturonic acid does not have ester like structure the experimental work related to its determination is described in this thesis as galacturonic acid content is an inherent parameter when it comes to pectin analysis. Together with methyl ester content, galacturonic acid content is used to determine

pectin degree of methyl esterification. Having developed method for pectin methyl esters determination it was tempting to focus on the development of methods for galacturonic acid.

Several methods for uronic acid content have been reported starting with spectrophotometric carbazole assay (Dische, 1947) later substituted by meta-hydroxydiphenyl (Blumenkrantz and Asboe-Hansen, 1973; Ibarz et al., 2006) or sulfamate/meta-hydroxydiphenyl (Filisetti-Cozzi and Carpita, 1991). Determination of uronic acid content by diffuse reflectance infrared Fourier transform spectroscopy (DRIFS) and the curve-fitting deconvolution method was also reported (Batsoulis et al., 2004)

The ideas for galacturonic acid quantification described in this thesis are based on galacturonic acid oxidation by iodine or cerium (IV). Suggested hydrolysis method should employ appropriate mixture of pectinases, enzymes accountable for pectin degradation.

### **3.3 Enzymes**

Enzymes are natural catalysts accountable for most reactions in living organisms. Enzymes, proteins build up by amino acids connected by peptide bonds, increase the reaction speed without undergoing any permanent modification themselves. Enzyme activity can be affected by the temperature, pH and enzyme or substrate concentration. Presence of inhibitors or activators influences the rate of enzyme catalyzed reaction. These molecules bind to the enzymes and slow down/speed up the reaction. Enzymes are widely used in detergents, textiles, food processing and pulp and paper industry. Examples of enzyme applications in food industry include baking, brewing, juice and wine production. By using enzymes and therefore eliminating harsh reagents, sustainability is introduced into the system. The system additionally benefits from increased selectivity, as enzymes tend to be specific towards the substrates of the reactions they catalyze (Worthington, Von, 1993). When developing a multi-enzyme system it is of special importance to take into account the stability and kinetics of all involved enzymes.



Due to the increasing use of enzymes in the food industry EU Commission decided to publish the EU Regulation for Food Enzymes<sup>4</sup>. This document establishes the rules on enzymes used for technological function at any stage of food production process, but also during product transportation or storage. The regulation was introduced in order to assure effective functioning of the internal market, human health protection, fair trade practices and environmental protection where relevant. In order to fulfill those aims a Community List with enzymes allowed on the food market will be created. The procedures related to the creation of the list are currently on going. The regulation also describes the rules on labeling of food enzymes.

---

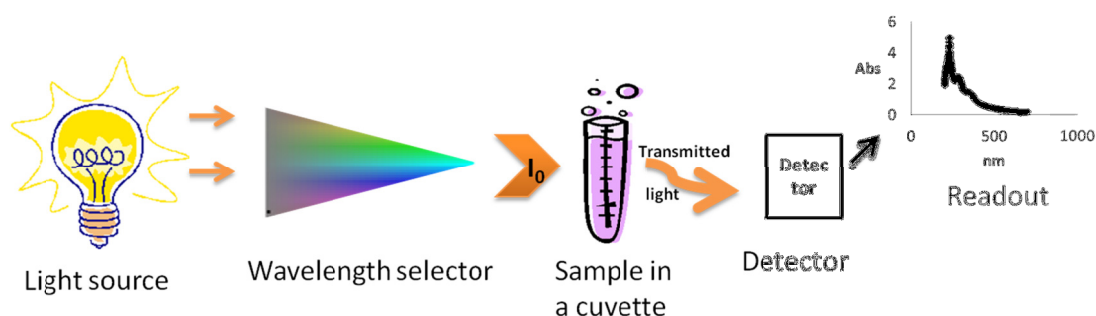
<sup>4</sup> Regulation (EC) No 1332/2008 of the European Parliament and of the Council of 16 December 2008 on food enzymes and amending Council Directive 83/417/EEC, Council Regulation (EC) No 1493/1999, Directive 2000/13/EC, Council Directive 2001/112/EC and Regulation (EC) No 258/9.

## 4. Detection methods

One of the powerful advantages of the automated methods of analysis is the flexibility when it comes to the choice of the detection method. Flow methods can be easily coupled with chemiluminescent, bioluminescent, fluorimetric, spectrophotometric or other detection principles. As mentioned before, within this project two detection methods have been used: spectrophotometry and chemiluminescence.

### 4.1. Spectrophotometry

Spectrophotometry is a detection method based on the principle that materials/samples absorb light at a certain wavelength. A beam of light goes through the sample placed in a cuvette of a spectrophotometer. The transmitted light intensity is measured (Figure 4.1).



*Figure 4.1 Spectrophotometry principle.*

Transmittance refers to the intensity of the light transmitted through the solution and it is the ratio between light transmitted through the sample ( $I$ ) to the light passing through the blank ( $I_0$ ):

$$T = I/I_0$$

Usually it is the absorbance (Figure 4.1), called also optical density (O.D.) that the readout from the spectrophotometer is presented in. The transmittance diminishes exponentially in relation to the concentration. Absorbance ( $A$ ) is presented as

logarithm of transmittance, and therefore is more powerful parameter in comparison to transmittance:

$$A = -\log T$$

The concentration of the absorbing species is directly proportional to the absorbance. This relation is described by Beer-Lambert law, according to which

$$A = \epsilon l c$$

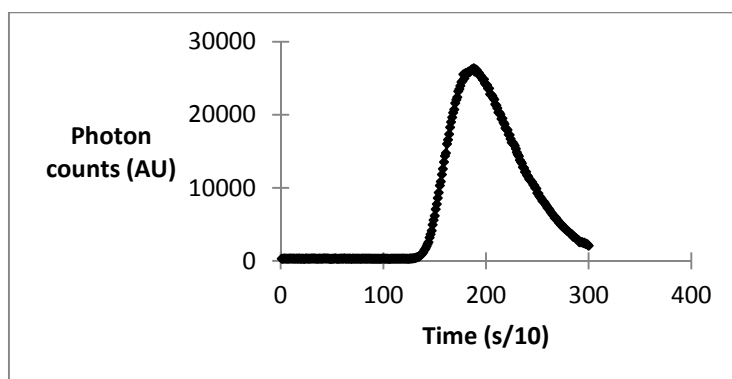
where  $\epsilon$  stands for molar extinction coefficient ( $M^{-1} \text{ cm}^{-1}$ ),  $l$  is path length of the sample (cm) and  $c$  is the concentration of the compound in the sample (M).

Spectrophotometry is an extremely common, cross-science analytical method widely used to determine concentration of target analytes in various types of samples. Wavelengths most commonly used in spectrophotometry are in the range of visible and UV spectrum (UV-vis). There are also spectrophotometers for infrared (IR) region. Spectrophotometric measurements are performed by means of spectrophotometers - photometers that are able to measure intensity of light at particular wavelength. Single-beam and double-beam spectrophotometers are used. Two light beams in double-beam instruments can be created by e.g. a mirror that splits the beam from the light source into two. One beam goes through the sample, while the second through the reference. Produced signals are then amplified. Double-beam design due to presence of internal light reference compensates for the variations in light intensity (Skoog et al., 1998).

## 4.2. Chemiluminescence

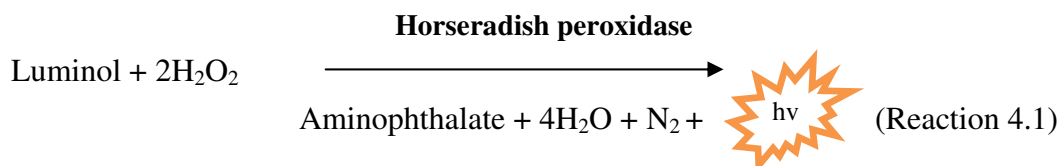
Chemiluminescent spectroscopy is based on monitoring light emission from a chemical reaction to determine concentration of an analyte. The source of the light are electronically excited species, which emit light while returning to lower energy level. Chemiluminescence produced by living organisms is called bioluminescence and is encountered in e.g. certain insects, bacteria, fungi and many marine species. Although the number of chemical compounds that produce chemiluminescence is limited, the sensitivity of the method compensates for this drawback. Detection limits usually range from parts per million to less than parts per trillion. Additional advantage is the

simplicity of the system, which requires only light detector. No wavelength selector or light source, as in case of spectrophotometry, is required. Typical signal from chemiluminescent measurement is presented in Figure 4.2. Chemiluminescence intensity increases rapidly up to a certain point and then falls exponentially forming a characteristic peak-shaped signal.



*Figure 4.2. Typical signal obtained from chemiluminescent measurement as a function of time.*

Luminol is one of the most commonly employed analytically useful chemiluminescent reagents often used within luminol-H<sub>2</sub>O<sub>2</sub>-horseradish peroxidase system (reaction 4.1). In order to increase the scope of the chemiluminescent determination to analytes that do not produce light upon oxidation chemiluminescent additional step in which hydrogen peroxide is produced by an oxidase is performed (Skoog et al., 1998). This logic was used when developing chemiluminescent method for aspartame determination described in Chapter 7.



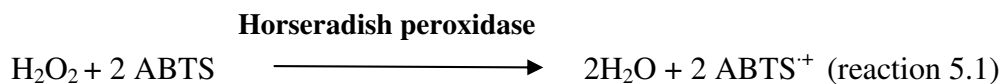
## Experimental part

### 5. Methanol determination

In this chapter two methods for methanol determination through hydrogen peroxide measurement are assessed for potential automation and compared. In both methods creation of a colored product is followed spectrophotometrically and the methanol concentration is related to the initial reaction rate. Both methods are based on the reactions catalyzed by enzymes alcohol oxidase and horseradish peroxidase but are involve different reagents. First method uses free radical 2,2'-azinobis(3-ethylbenzthiazoline-6-sulfonic acid) i.e. ABTS while the second uses 4-aminoantipyrine (4-AAP) and phenol. Elimination of ascorbic acid interference using 4-hydroxy TEMPO is also presented. Attempt to apply 4-AAP/phenol method to pectin methylesterase activity assay is described. Further on, methanol determination method by formaldehyde measurement is looked into and evaluated as a candidate for automation.

#### 5.1. Hydrogen peroxide measurement with ABTS

The suitability of automation of the method of Mangos and Haas (Mangos and Haas, 1996) was assessed. That was done by evaluating the calibration curve as well as blank signal acquired. Method is based on conversion of methanol to formaldehyde and hydrogen peroxide (reaction 3.1). Hydrogen peroxide reacts further with ABTS (reaction 5.1). The reaction rate is followed spectrophotometrically.



#### *Materials and methods*

Alcohol oxidase and ABTS were purchased from Sigma-Aldrich (St. Louis, MO, USA) and horseradish peroxidase from Serva (Heidelberg, Germany). All other reagents were analytical grade.

0.24 mM methanol stock solution was prepared in 0.2 M phosphate buffer, pH 7.6. From the stock solution calibration standard methanol solutions of following concentrations: 0.0075, 0.015 and 0.03 mM were prepared. 9.7 mM ABTS solution

was prepared by dissolving one tablet of ABTS in 2 ml deionized water. 1.7 mg HRP was dissolved in 2 ml deionised water. 20 µl of this solution was diluted to 1 ml to obtain the 15 U/ml solution.

For calibration curves 20 µl of 9.7 mM ABTS and 20 µl HRP (0.3 U) were mixed with 100 µl methanol standard and vortexed for 2 seconds. 90 µl of this mixture was transferred to an ultra-micro cell placed in the spectrophotometer. 15 µl of AOX (0.375 U) was added and time course measurement program was started immediately at 420 nm. Jasco 550-V spectrophotometer was used.

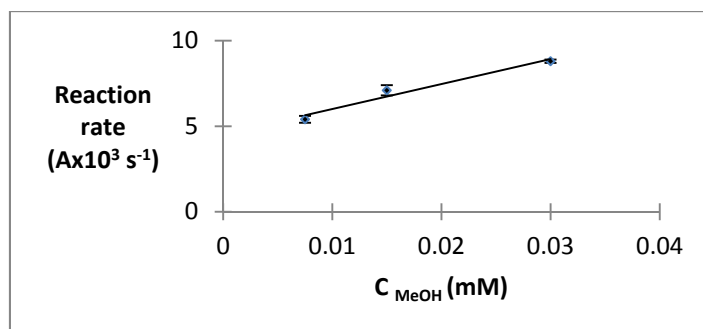
Due to the observation of blank signal during initial experiments it was decided to investigate what was the parameter responsible for that. Measurements were performed for the following solutions a) 1000 µl buffer, b) 1000 µl buffer with 20 µl 9.7 mM ABTS, c) 1000 µl buffer with 20 µl HRP (0.3 U), d) 1000 µl buffer, 20 µl 9.7 mM ABTS and 20 µl HRP (0.3 U) (Table 5.1, set 1). For each a-d measurement analogous measurement with AOX was performed (Table 5.1, set 2). The experimental setup for analysis of blank signal is presented in Table 5.1.

**Table 5.1** Experimental setup for blank signal analysis with ABTS method.

solution	ABTS	HRP	AOX
<b>Set 1: w/o AOX</b>			
a	-	-	-
b	✓	-	-
c	-	✓	-
d	✓	✓	-
<b>Set 2: with AOX</b>			
a	-	-	✓
b	✓	-	✓
c	-	✓	✓
d	✓	✓	✓

### **Results and discussion**

Calibration curve based on ABTS method is presented in Figure 5.1.



**Figure 5.1** Methanol calibration curve<sup>5</sup> constructed using ABTS:  $\Delta A/\Delta t$  ( $A \times 10^3$ ) =  $(146 \pm 28) C$  (mM) +  $(4.6 \pm 0.6)$ ,  $r=0.98$ .

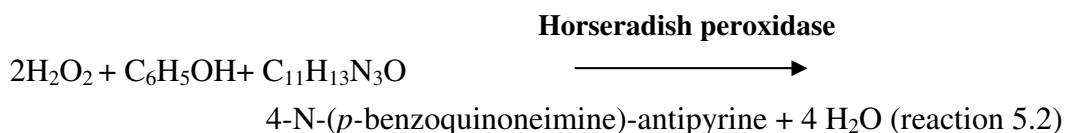
The most influential parameter concerning the blank value was alcohol oxidase. Blank reaction rate of up to  $2.61 \pm 0.01 A \times 10^3 s^{-1}$  was observed even when amounts as small as 0.3 U/ml AOX were present during the measurement. The increase was not observed when AOX was not present during the measurement (set 1, Table 5.1).

Mangos and Haas, 1996, who used ABTS, suggest that the increase in the blank might be a result of oxidation of formaldehyde which is reversibly bound to AOX. AOX oxidizes this formaldehyde to formic acid and hydrogen peroxide, which is further a substrate for peroxidase catalyzed reaction (Hopkins and Muller, 1987).

Significant blank signal encouraged the trial of a similar methanol determination method based on hydrogen peroxide reaction with 4-aminoantipyrine and phenol.

## 5.2. Hydrogen peroxide measurement with 4-AAP/phenol

Hydrogen peroxide resulting from the oxidation of methanol by AOX (reaction 3.1) reacts further in a reaction with 4-AAP and phenol catalyzed by HRP (reaction 5.2). Creation of colored product is followed spectrophotometrically.



Method was optimized and its robustness was assessed. Additionally removal of ascorbic acid interference with 4-hydroxy TEMPO was tested. The 4-APP/phenol

<sup>5</sup> Calibration data constructed out of three points are presented to show trends and were not used for sample concentrations calculations.

method was assessed for application in pectin methylesterase (PME) activity assay. Two different approaches, depending on the PME source were studied.

### ***Materials and methods***

Enzyme working solution (EWS) contained 1 U/ml AOX and 40 U/ml HRP, 7.5 mM phenol, 2.5 mM 4-AAP in 0.1 M phosphate buffer. Appropriate amounts of phenol, 4-AAP and  $\text{KH}_2\text{PO}_4$  were weighted and dissolved in deionized water. After adjustment of pH to 7.5 with 1 M NaOH, appropriate amounts of AOX and HRP were added. The solution was transferred to a volumetric flask and brought to volume (Vasilarou and Georgiou, 2000). This procedure was used throughout the experiments described in this thesis unless stated differently. Enzymes and 4-AAP were purchased from Sigma Aldrich. Reagents were analytical grade.

A kinetic study of the influence of temperature and pH on the EWS was performed.

EWS used for pH influence study was prepared as usually, however pH was not adjusted with 1 M NaOH but by filling to volume with 0.1 phosphate buffers of pH 6.5, 7 and 7.5. The effect of following AOX activities 0.5, 1.0, 1.5, 2.0 2.5 U/ml was examined on 7.6 mM methanol standard. Stability of the EWS upon 3 months storage in the fridge was studied.

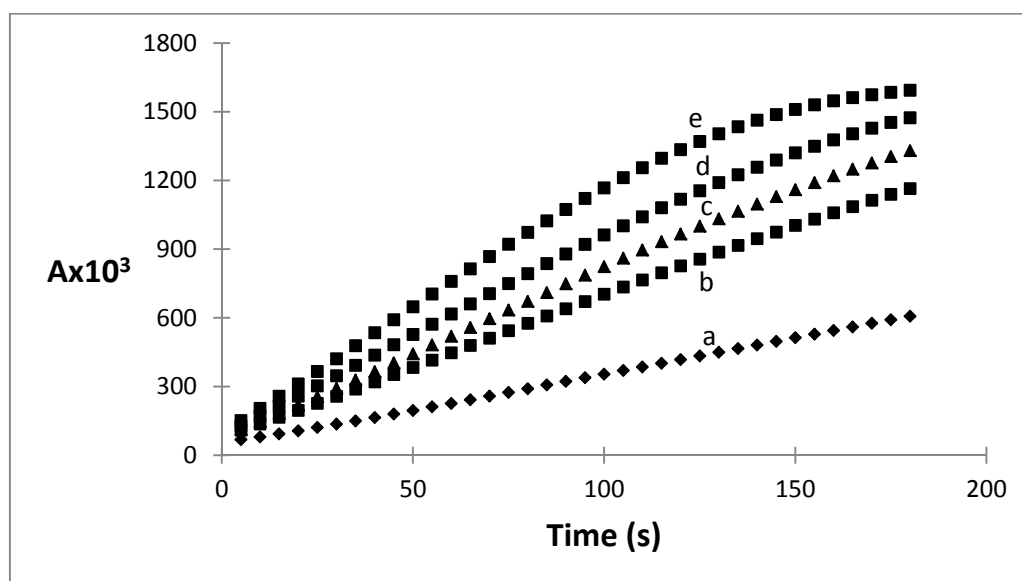
Experimental procedure: 0.5 ml of MeOH standard was placed in the quartz cuvette of Jasco V-550 spectrophotometer and 2.5 ml EWS was added. The time course measurement program was started immediately to monitor reaction rate at 505 nm for 2-5 minutes. Reagent blanks were subtracted from the analytical signal where necessary. Reaction rates were calculated in units of  $\text{A} \times 10^3 \text{ s}^{-1}$  throughout all studies described in this thesis.

### ***Results and discussion***

To assure that measured reaction rate is proportional to methanol concentration, the methanol oxidation reaction (reaction 3.1) must be the rate limiting step. On the other hand, the HRP catalyzed reaction (reaction 5.2) should be very fast. The influence of AOX concentration on the reaction curves is presented in Figure 5.2. When AOX activities higher than 1.5 U/ml are used, methanol is consumed within the monitoring time and linearity is lost towards the end of the measurement. In contrast, low AOX

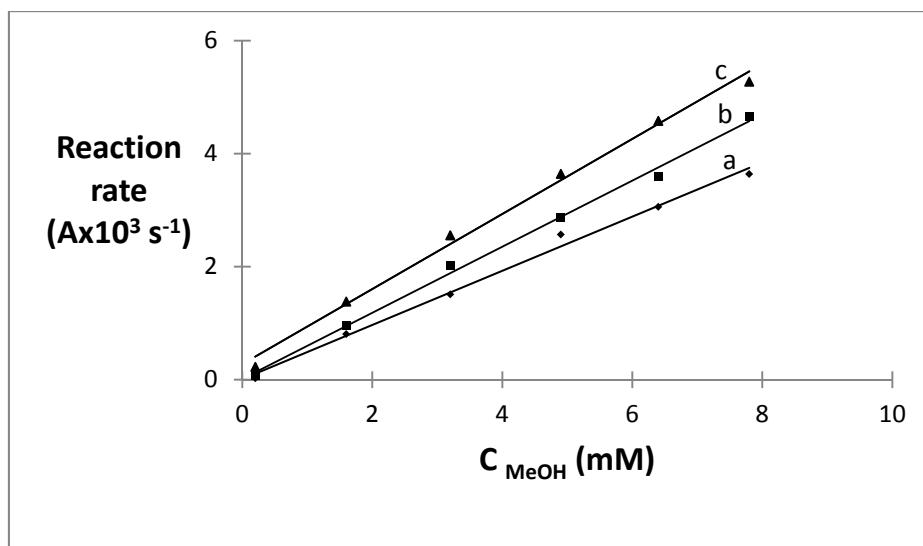


activities, such as 0.5 U/ml result in lower reaction rates. The activity of 1/U ml was chosen as a tradeoff between high analytical signal and linearity.



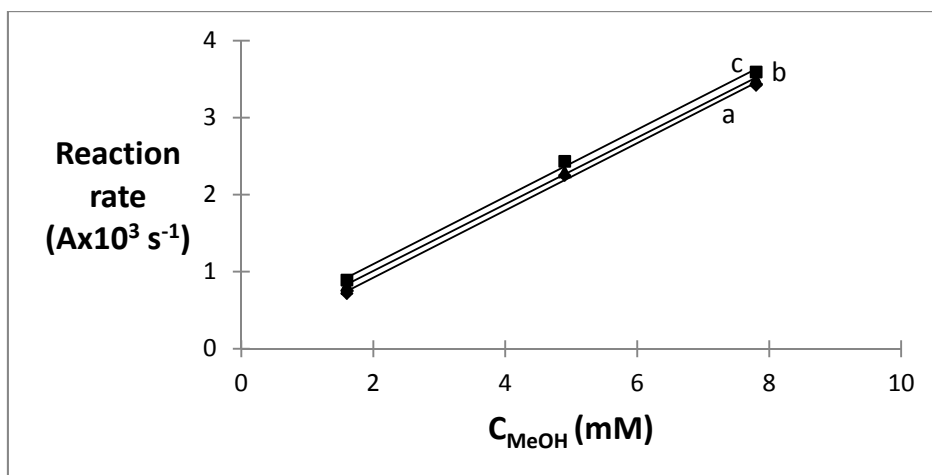
**Figure 5.2** Alcohol oxidase concentration influence on the analytical signal. AOX concentrations: a) 0.5, b) 1, c) 1.5, d) 2 and e) 2.5 U/ml. Calibration equations: a)  $A (Ax10^3) = (3.12 \pm 0.01) t (s) + (43 \pm 1)$ ,  $r = 0.9998$ , b)  $A (Ax10^3) = (6.12 \pm 0.02) t (s) + (79 \pm 2)$ ,  $r = 0.9997$ , c)  $A (Ax10^3) = (7.14 \pm 0.05) t (s) + (89 \pm 5)$ ,  $r = 0.9991$ , d)  $A (Ax10^3) = (8.0 \pm 0.1) t (s) + (13 \pm 1)$ ,  $r = 0.997$ , e)  $A (Ax10^3) = (8.8 \pm 0.2) t (s) + (198 \pm 25)$ ,  $r = 0.99$ .

Robustness of the method strongly depends on the pH and temperature that affect enzyme activity. Figure 5.3 shows the effect of the EWS temperature in the range 20-30 °C. The reaction rate increases just  $0.02 Ax10^3 s^{-1} °C^{-1}$ .



**Figure 5.3** Calibration data obtained at different temperatures a: 20°C  $\Delta A \Delta t^{-1}$  ( $A \times 10^3 s^{-1}$ ) =  $(0.48 \pm 0.02) C + (0.01 \pm 0.01)$ , b: 25°C  $\Delta A \Delta t^{-1}$  ( $A \times 10^3 s^{-1}$ ) =  $(0.58 \pm 0.02) C + (0.01 \pm 0.09)$   $r=0.998$   $r = 0.997$ , c: 30°C  $\Delta A \Delta t^{-1}$  ( $A \times 10^3 s^{-1}$ ) =  $(0.66 \pm 0.03) C + (0.3 \pm 0.1)$ ,  $r = 0.997$ .

Investigating the most optimal pH for the EWS was of special importance since enzymes in the EWS have different optimal pH: 7.5 for AOX (Couderc and Baratti, 1980) and 6-6.5 for HRP (Schomberg et al., 1993). Figure 5.4 shows that pH changes of the enzyme working solution in the 6.5 – 7.5 range do not have any influence on the reaction rate.



**Figure 5.4.** pH influence on the calibration curve<sup>6</sup>. a: pH 6.5:  $\Delta A \Delta t^{-1} (Ax10^3 s^{-1}) = (0.44 \pm 0.02) C + (0.0 \pm 0.1)$ ,  $r=0.9991$ , b: pH 7.5:  $\Delta A \Delta t^{-1} (Ax10^3 s^{-1}) = (0.433 \pm 0.009) C + (0.15 \pm 0.05)$ ,  $r= 0.9998$ , c: pH 7.0:  $\Delta A \Delta t^{-1} (Ax10^3 s^{-1}) = (0.44 \pm 0.02) C + (0.2 \pm 0.1)$ ,  $r=0.999$ .

To summarize, the influence of the temperature and pH on the reaction proved to be minor and the robustness of the method was confirmed. A long term stability study showed 19.5 % and 30% loss of EWS activity after 48 and 99 days, respectively (Table 5.2)

**Table 5.2.** Long term stability study.

Storage time (days)	Reaction rate ( $Ax10^3 s^{-1} \pm$ SE)	Activity loss (%)
0	$0.6 \pm 0.1$	--
48	$0.483 \pm 0.004$	19.5
99	$0.42 \pm 0.02$	30

<sup>6</sup> Calibration data constructed out of three points are presented to show trends and were not used for sample concentrations calculations.

## 5.2.1. Removal of ascorbic acid interference

### *Materials and methods*

HRP, AOX, ascorbate oxidase and 4-hydroxy TEMPO were from Sigma Aldrich. Ascorbic acid was from Alfa Aesar (Ward Hill, MA, USA). EWS was prepared as described on page 25, apart from methanol measurement in juices, where AOX concentration was 2.5 U/ml and HRP concentration 20 U/ml. Additionally, EWS used for the measurement in juices in which 4-hydroxy TEMPO is used as ascorbic acid quencher, was fortified with 2 mM 4-hydroxy TEMPO. All reagents were of analytical grade. Orange juice was freshly squeezed and filtered. All experiments were performed using time course measurement of Jasco V-550 spectrophotometer at 505 nm.

### Measurement in orange juice

For methanol measurements in orange juice 10 U/ml ascorbate oxidase was prepared in 0.1 M phosphate buffer, pH 5.6 and 10 mM 4-hydroxy TEMPO was prepared in 0.1 M phosphate buffer by dissolving appropriate amounts of the reagents in the buffers.

Experimental procedure: 0.5 ml filtered orange juice was preincubated with 0.5 ml ascorbate oxidase or 4-hydroxy TEMPO for 60 s or 200 s, respectively. 2.5 ml EWS was added without ascorbic acid quenchers or with 2 mM 4-hydroxy TEMPO, respectively.

### Reaction curves

5, 20, 40, 60, 80, 100, 120 mM 4-hydroxy TEMPO solutions were prepared by dissolving appropriate amounts of the reagent in phosphate buffer. Methanol standard containing 7.81 mM methanol and 5.7 mM ascorbic acid in phosphate buffer was used through experiment. EWS was prepared as described on page 25.

Experimental procedure: 0.5 ml standard, was mixed with 0.5 ml 4-hydroxy TEMPO of different concentrations. 2.5 ml of EWS was added and the software was started immediately.

#### 4-hydroxy TEMPO concentration influence on the reaction rate

2, 4, 6, 8, 10, 12 and 14 mM 4-hydroxy TEMPO solutions were prepared by dissolving appropriate amounts of 4-hydroxy TEMPO in 0.2 M phosphate buffer pH 6. These were used for investigating 4-hydroxy TEMPO concentration influence on the reaction rate. Standard containing 2.19 mM MeOH and 1.7 mM ascorbic acid was used. EWS prepared as described on page 25.

Experimental procedure: 0.5 ml standard was mixed with 0.5 ml 4-hydroxy TEMPO of different concentrations and preincubated for 10 minutes. 2.5 ml EWS was added and the software was started immediately.

#### Removal of ascorbic acid

Standards contained 2.19 or 3.44 mM MeOH and were prepared with or without 1.7 mM ascorbic acid in RO. 6 mM 4-hydroxy Tempo was used. EWS was as described on page 25.

Experimental procedure: 0.5 ml standard was mixed with 0.5 ml 6 mM 4-hydroxy TEMPO and preincubated for 10 minutes. 2.5 ml EWS was added and the software was started immediately.

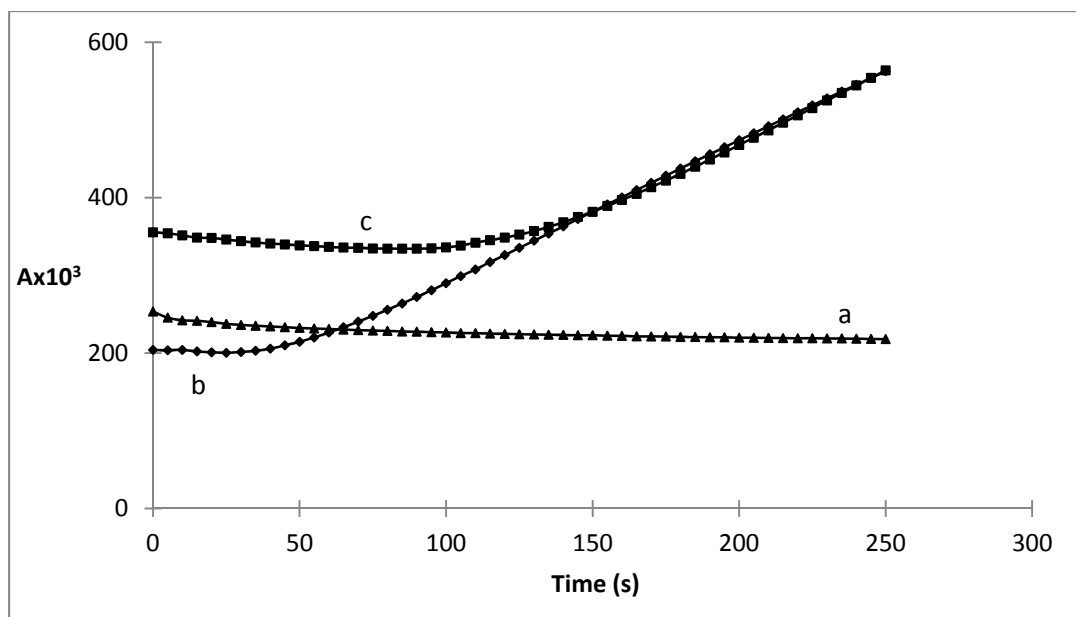
#### Influence of different 4-hydroxy TEMPO concentrations on the reaction rate

7.81 mM methanol standard was used. 5, 20, 40, 60, 80 and 100 mM 4-hydroxy TEMPO solutions were prepared by dissolving appropriate amounts of 4-hydroxy TEMPO in 0.1 M phosphate buffer, pH 7.5. EWS was prepared as described on page 25.

Experimental procedure: 0.5 ml standard was mixed with 0.5 ml 4-hydroxy TEMPO of different concentrations and preincubated for 2 minutes. 2.5 ml EWS was added and the software was started immediately.

#### ***Results and discussion***

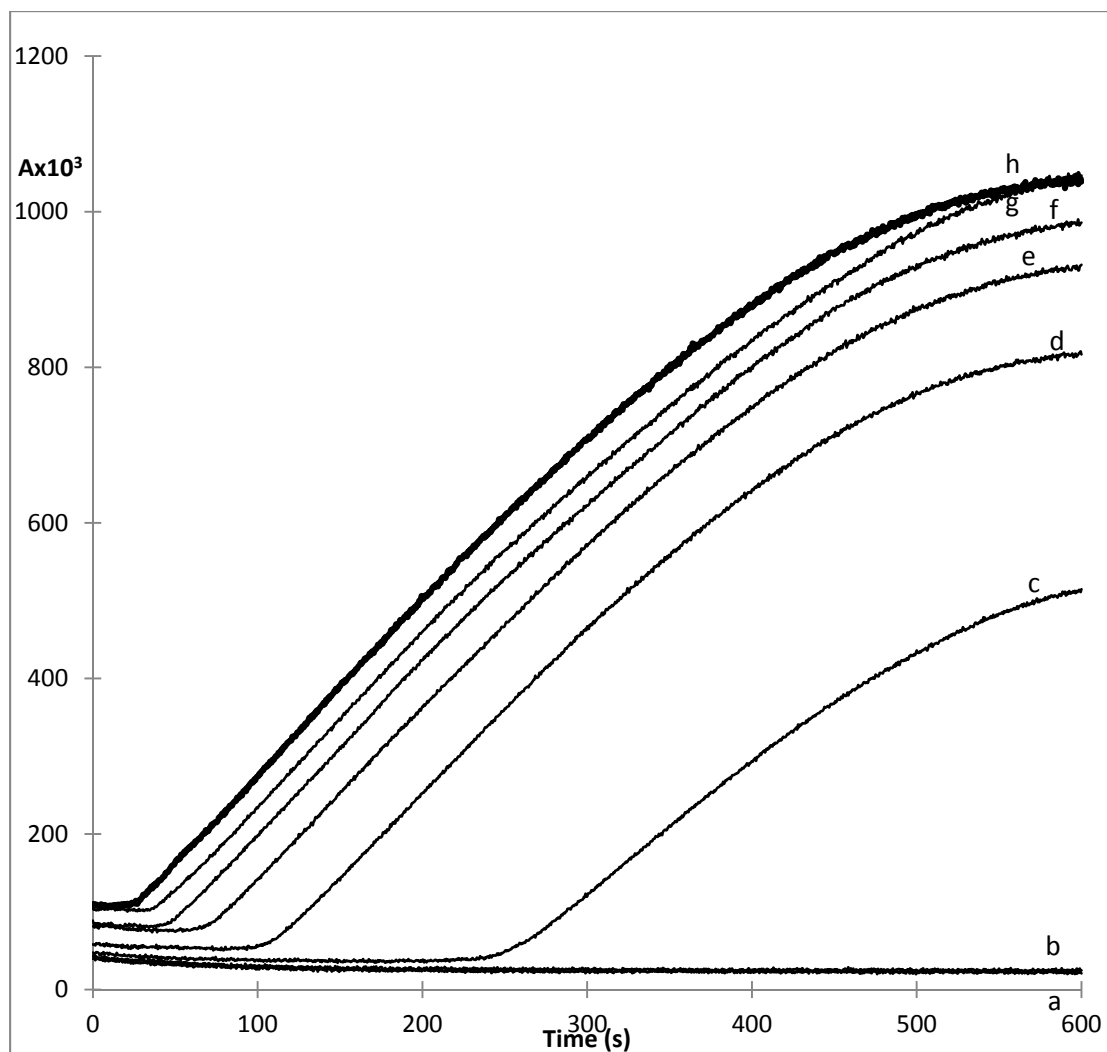
During the measurement of methanol in orange juices, ascorbic acid consumes hydrogen peroxide (reaction 3.2) and this results in a negative reaction rate as presented in Figure 5.5 (line a).



**Figure 5.5** Removal of ascorbic acid interference: a) without removing ascorbic acid interference, b) after 60 s preincubation with ascorbate oxidase, c) after 200 s preincubation with 4-hydroxy TEMPO. Orange juice samples.

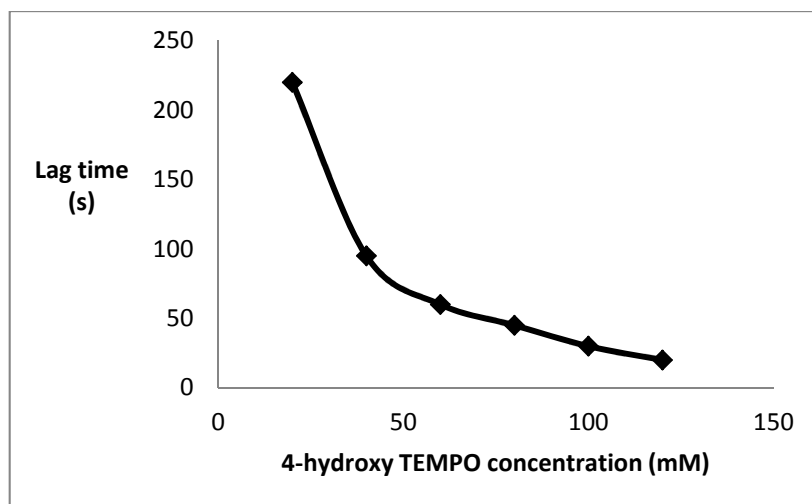
When ascorbic acid is removed by preincubation with ascorbate oxidase (figure 5.5, line b) or 4-hydroxy TEMPO (figure 5.5, line c) reaction rates can be measured after a short lag time. The lag time of around 50 s and 140 s was needed when ascorbate oxidase and 4-hydroxy TEMPO were used, respectively. As presented in Figure 5.5 the reaction rates after 140 s lag time are the same.

The efficiency of 4-hydroxy TEMPO to quench ascorbic acid was further tested. As expected, it was observed that 4-hydroxy TEMPO concentration influences the duration of the lag time (Figure 5.6).



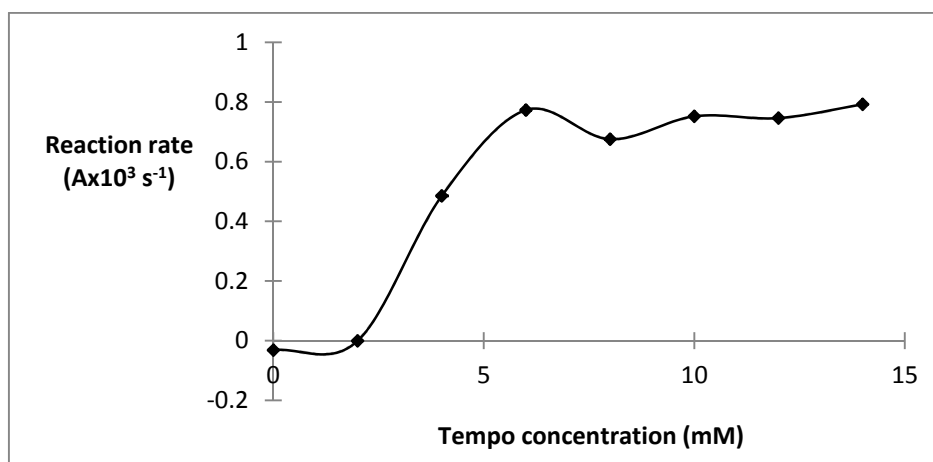
**Figure 5.6.** Reaction curves for the determination of 7.81 mM methanol in a mixed solution with 5.7 mM ascorbic acid using different 4-hydroxy TEMPO concentrations: a) 0, b) 5, c) 20, d) 40, e) 60 and f) 80 mM.

As shown in the Figure 5.6 the lag time is related to the 4-hydroxy TEMPO concentration. This is shown further in Figure 5.7. Lag time is decreasing along increasing 4-hydroxy TEMPO concentration.



**Figure 5.7** Relation of the lag time to 4-hydroxy TEMPO concentration.

The influence of 4-hydroxy TEMPO concentration in the range 0-14 mM on the reaction rate for standard containing 2.19 mM MeOH and 1.7 mM ascorbic acid is presented in Figure 5.8. The signal increases along increasing 4-hydroxy TEMPO concentration with 6 mM being the optimum.



**Figure 5.8.** Effect of 4-hydroxy TEMPO concentration on the reaction rate of 2.19 mM MeOH standard containing 1.7 mM ascorbic acid.

Up to 96 % interference was removed by 10 minutes preincubation with 6 mM 4-hydroxy TEMPO from 3.44 mM methanol standard containing 1.7 mM ascorbic acid (Table 5.3).



*Table 5.3. Removal of ascorbic acid.*

<b>C<sub>MeOH</sub> (mM)</b>	<b>Reaction rate ± SE with ascorbic acid</b>	<b>Reaction rate ± SE w/o ascorbic acid</b>	<b>Removal of ascorbic acid interference (%)</b>
2.19	0.821 ± 0.003	0.869 ± 0.003	94.5
3.44	1.372 ± 0.003	1.434 ± 0.003	95.7

The presence of 4-hydroxy TEMPO in the reaction mixture does not influence the reaction rate for the 7.81 mM methanol standard without ascorbic acid. As shown in Table 5.4 4-hydroxy TEMPO does not interfere with the system.

*Table 5.4. Influence of different 4-hydroxy TEMPO concentrations on the reaction rate for 7.81 mM methanol standard w/o ascorbic acid.*

<b>Tempo concentration (mM)</b>	<b>Reaction rate (Ax10<sup>3</sup> s<sup>-1</sup> ± SE)</b>
0	3.277 ± 0.003
5	3.269 ± 0.004
20	3.238 ± 0.004
60	3.277 ± 0.004
80	3.378 ± 0.003
100	3.233 ± 0.004

To conclude, preincubation with 4-hydroxy TEMPO removes interference caused by small amounts of ascorbic acid without affecting the system.

### **5.2.2. Relative response: methanol/ethanol**

Although AOX has the highest affinity towards methanol it also catalyzes oxidation of other short chain alcohols. The comparison of AOX affinity towards methanol and

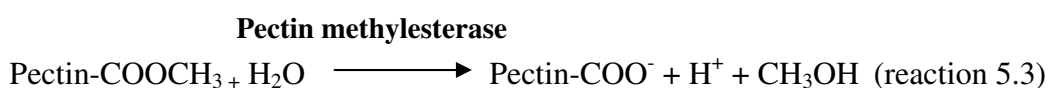
ethanol, which is commonly present in small amounts in foodstuffs and soft drinks (Logan and Distefano, 1998), is shown in Table 5.5. The relative response ratio of methanol/ethanol is 19 at 0.25 mM and 26 at 1.23 mM. This proves that, for samples where concentrations of methanol and ethanol are equal, the influence of AOX acting on ethanol is insignificant.

**Table 5.5** Comparison of alcohol oxidase affinity towards methanol and ethanol.

<b>C<sub>alcohol</sub> (mM)</b>	<b>Reaction rate (Ax10<sup>3</sup> s<sup>-1</sup> ± SE)</b>	
	<b>MeOH</b>	<b>EtOH</b>
0.25	0.130 ± 0.002	0.007 ± 0.002
1.23	0.68 ± 0.002	0.026 ± 0.002

### 5.2.3. PME assay

Methanol determination method based on measuring hydrogen peroxide with 4-aminoantipyrine/phenol has been assessed for application in pectin methylesterase activity assay. In the tested PME activity assay methanol released by PME (reaction 5.3) is measured by methanol determination through hydrogen peroxide measurement using 4-AAP and phenol (reactions 3.1 and 5.2).



Two different approaches, depending on the PME source – fungal or plant, were investigated.

#### Fungal PME

#### **Materials and methods**

Pectin donated by CP Kelco ApS (Lille Skensved, Denmark), and pectin from Sigma Aldrich was used through the study. EWS as described on page 25 was used. A commercial preparation of a recombinant *Aspergillus oryzae* pectin methylesterase

(PME) (EC 3.1.1.11) (Novoshape, Novozymes, Bagsvaerd, Denmark) was a generous gift from Dr. Hans Sejr Olsen.

Experimental procedure: 0.5 ml of pectin was placed in the quartz cuvette of Jasco V-550 spectrophotometer. 25-500  $\mu$ l PME was added and then after 0-10 min preincubation 2.5 ml EWS was added. The time course measurement program was started immediately to monitor reaction rate at 505 nm. Reagent blanks measurements with deionized water were performed. The influence of following parameters on the reaction rate was tested:

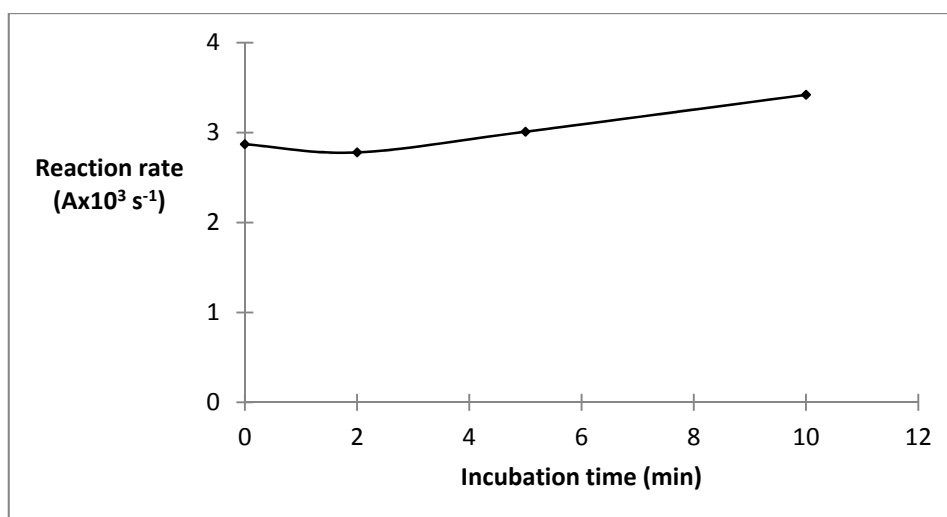
- i) preincubation time,
- ii) preincubation temperature,
- iii) PME activity.

Finally it was necessary to investigate whether the 4AAP/methanol method originally developed for methanol determination, which is operating at the pH of 7.5 can be used also at the acidic pH, since the optimal pH of PME from Novoshape is 4.6 (Christgau et al., 1996). This was done by an attempt to compare the calibration curves prepared with EWS in the pH range of 4.9-7.6. EWS of pH 4.9 and 5.8 were prepared in 0.2 M acetate buffer and EWS of pH 6.8 and 7.6 in 0.2 M phosphate buffer. Following methanol standards were used: 0.05, 0.25, 1.23 and 2.47 mM. Methanol standards and buffers were prepared in RO water. Measurements were performed by mixing 0.5 ml methanol standard or blank (RO water) with 2.5 ml EWS with Jasco V-550 time course measurement mode.

## ***Results and discussion***

### **Preincubation time**

As expected and presented in Figure 5.9 slight increase in the reaction rate is observed with increasing preincubation time. Preincubation time is the time allowed for the pectinesterase action on methyl ester groups, here on 0.5 % w/v pectin.



**Figure 5.9** Preincubation time influence on the reaction rate.

### Preincubation temperature

Temperature effect in the range 23-40 °C on the reaction rate was investigated (Table 5.6). As expected the reaction rate increases with reaction temperature. No influence on the blank was observed.

**Table 5.6** Temperature influence on the reaction rate. 0.5 % w/v pectin and 10 min preincubation time were used.

Temperature (°C)	Reaction rate (Ax10 <sup>3</sup> s <sup>-1</sup> ) ± SE	
	Sample	Blank
23	3.42 ± 0.01	0.3 ± 0.002
25	4.19 ± 0.01	0.3 ± 0.002
40	4.815 ± 0.005	0.3 ± 0.002

### PME activity

Data presented in Table 5.7 show that the analytical signal, that is the difference between the reaction rate and the blank, increases along PME activity up to 0.250 U/ml while at 0.300 U/ml a small decrease, probably due to the saturation, is

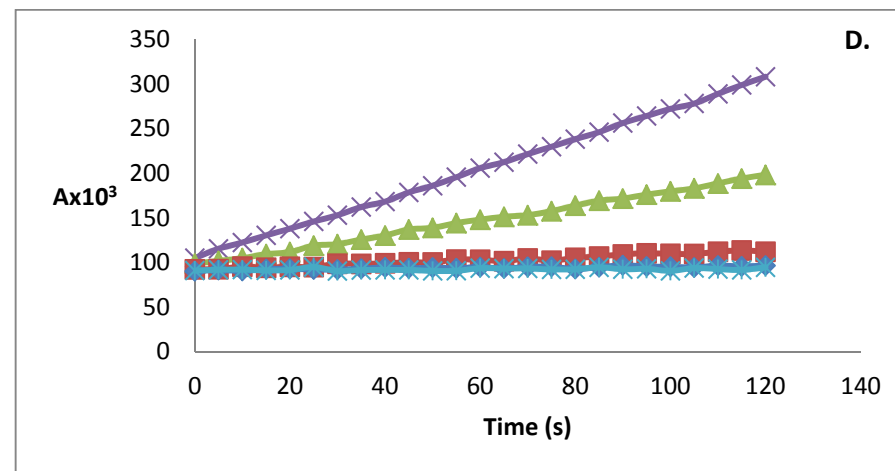
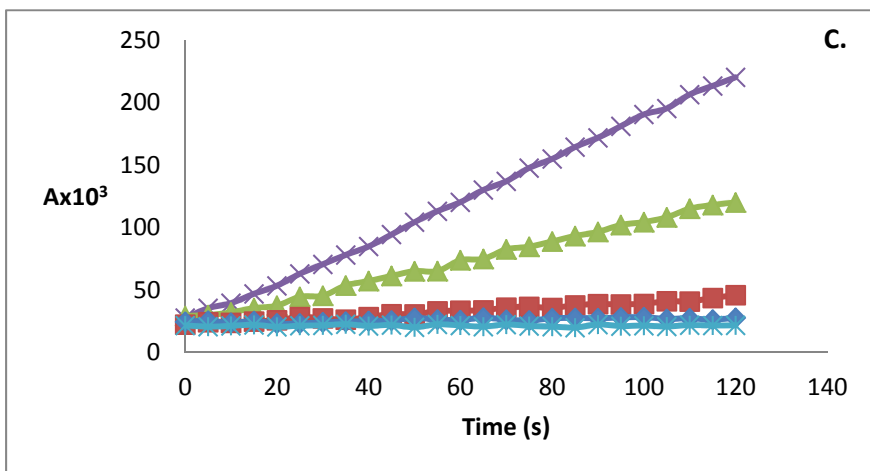
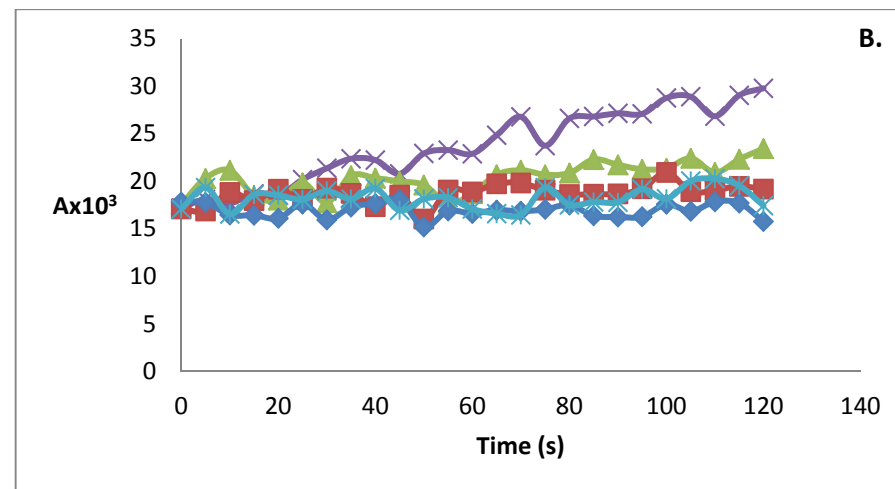
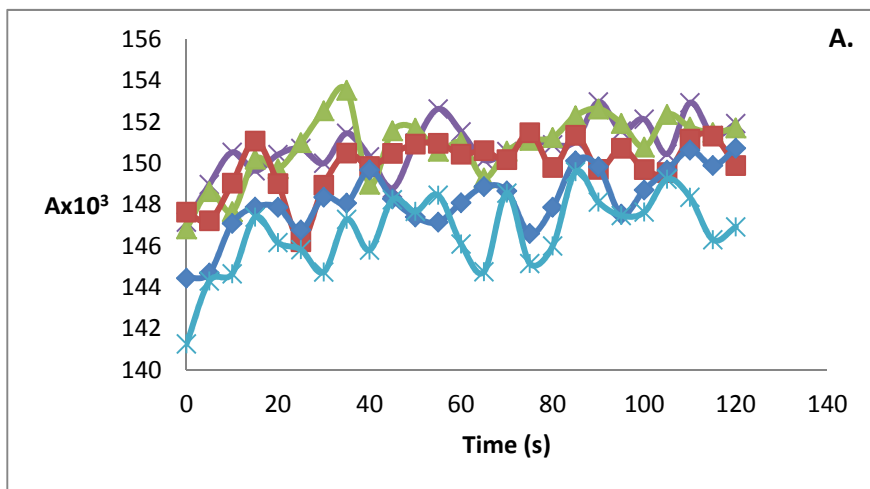
observed. The increase in the blank is most likely due to glycerol that is used as a stabilizer in the Novoshape preparation. Alcohol oxidase reacts with primary alcohols, therefore also with glycerol. This explains the blank increase along PME activity. Correlation coefficients ( $R^2$ ) for reaction rates were from 0.98 to 0.997 for pectin sample and from 0.517 to 0.99 for blank.

*Table 5.7 Effect of PME activity on the reaction rate at pH 3.5 on 0.2% w/v pectin.*

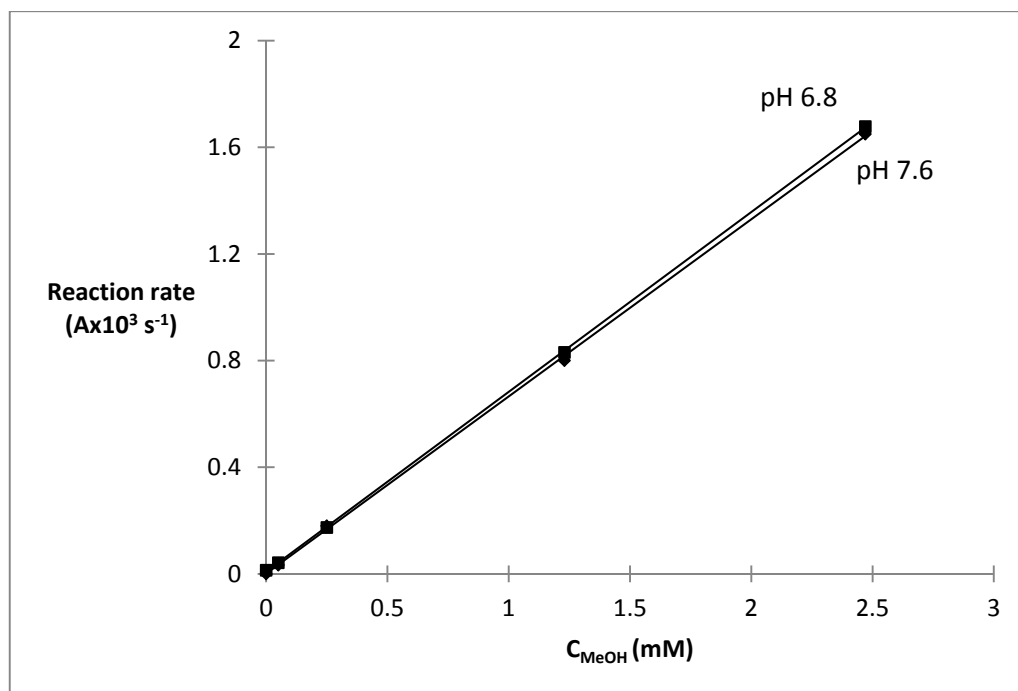
PME activity (U/ml)	Reaction rate ( $A \times 10^3 \text{ s}^{-1}$ ) $\pm$ SE		
	Sample	Blank	Analytical signal Sample – Blank
0.033	0.263 $\pm$ 0.002	0.036 $\pm$ 0.002	0.227
0.100	0.722 $\pm$ 0.004	0.097 $\pm$ 0.002	0.625
0.133	0.817 $\pm$ 0.004	0.134 $\pm$ 0.002	0.683
0.167	1.089 $\pm$ 0.004	0.193 $\pm$ 0.002	0.896
0.250	1.274 $\pm$ 0.005	0.275 $\pm$ 0.002	0.999
0.333	1.362 $\pm$ 0.005	0.369 $\pm$ 0.002	0.993

#### Influence of EWS pH

EWS does not work in acidic pH (Figure 5.9, A and B). When EWS pH of 6.8 and 7.6 was used almost identical calibration curves were constructed:  $\Delta A/\Delta t = 0.664 (\pm 0.006) C + 0.001 (\pm 0.08)$  and  $\Delta A/\Delta t = 0.675 \pm 0.003) C + 0.008 (0.003)$  respectively (Figure 5.10).



**Figure 5.9.** Influence of EWS pH. pH: A) 4.9, B) 5.8, C) 6.8, D) 7.  $C_{MeOH}$ : 6.0 mM (light blue), 0.05 mM (dark blue), 0.25 mM (dark red), 1.23 mM (green), 2.47 mM (violet).



**Figure 5.10** Calibration curves constructed using EWS of pH 6.8 and 7.6.

## Plant PME

### **Materials and methods**

Pectin donated by CP Kelco ApS (Lille Skensved, Denmark) and by Dr. Karen Marie Søndergaard, DuPont NHIB Denmark ApS was used for the assay and comparison method.

PME stock solution (92 U/ml) was prepared by diluting appropriate amount of PME in cold 10 % NaCl. 0.5 % w/v pectin was prepared by dissolving appropriate amount of pectin in deionised water. EWS was prepared according to the instructions on page 25. Also experimental procedure described in there was followed for constructing calibration curve with methanol standards 0.05, 0.25, 1.23 and 2.47 mM. For plant PME activity measurement 0.92 U PME from orange peel from Sigma Aldrich was added to 0.5 ml 0.5 % w/v pectin, followed by immediate addition of 2.5 ml EWS and activity measurement for 1 minute. The results of the enzymatic assay were compared with label data provided by the PME producer: 597 units/mg protein, 154 units/mg solid (Lot # 031M7673V).

The influence of following parameters on the reaction rate was tested:

i) preincubation time,

ii) PME activity.

For the investigation of the preincubation time influence on the reaction rate 0.18 and 0.92 U PME and 0.5 ml pectin were preincubated for 0, 1, 2, 5,10 minutes before addition of EWS. PME activity influence on the reaction rate was also tested by adding 0.18-1.85 U PME to 0.5 % w/v pectin. The activities were calculated based on the data provided by the producer.

### ***Results and discussion***

#### **Preincubation time influence**

The influence of preincubation time of plant PME with pectin is shown in Table 5.8. The influence of preincubation time has proven to be insignificant and therefore the preincubation step was eliminated from the plant PME assay.

***Table 5.8. Preincubation time influence on the reaction rate performed with 0.18 and 0.92 U PME.***

	<b>Reaction rate <math>\pm</math> SE (<math>A \times 10^3 \text{ s}^{-1}</math>)</b>	
<b>PME activity U</b>	<b>0.18</b>	<b>0.92</b>
<b>Preincubation time (min)</b>		
<b>0</b>	0.517 $\pm$ 0.007	1.02 $\pm$ 0.01
<b>1</b>	0.543 $\pm$ 0.006	1.13 $\pm$ 0.01
<b>2</b>	0.525 $\pm$ 0.006	1.11 $\pm$ 0.01
<b>5</b>	0.569 $\pm$ 0.006	1.2 $\pm$ 0.01
<b>10</b>	0.528 $\pm$ 0.006	1.24 $\pm$ 0.01



### PME activity influence

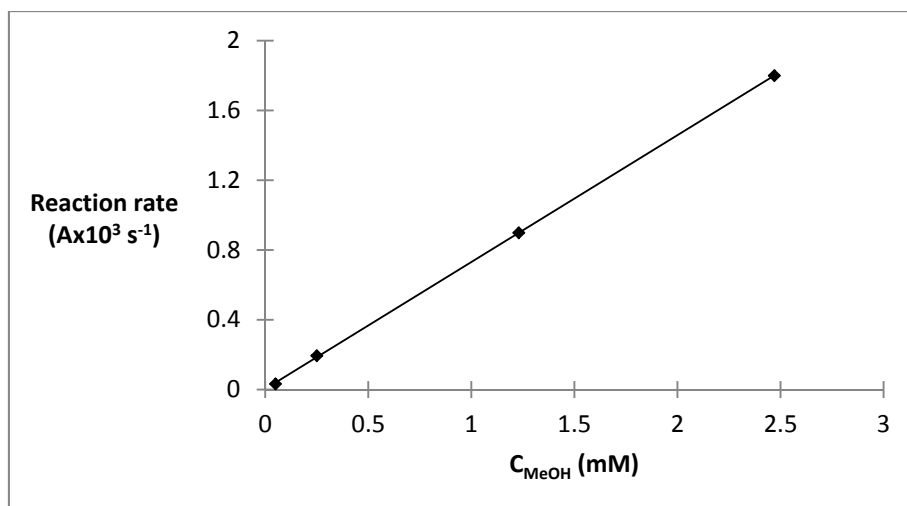
As expected the reaction rate increases along PME activity increase (Table 5.9).

*Table 5.9 PME activity influence on the reaction rate.*

<b>Activity (U)</b>	<b>Reaction rate (<math>A \times 10^3 \text{ s}^{-1}</math>) <math>\pm</math> SE</b>
0.18	$0.517 \pm 0.007$
0.65	$0.77 \pm 0.01$
0.92	$1.02 \pm 0.01$
1.39	$1.18 \pm 0.02$
1.85	$1.44 \pm 0.03$

### Assay validation

According to the PME activity definition one unit will release 1.0 microequivalent of acid from pectin per min at pH 7.5 at 30 °C. According to the calibration curve for enzymatic method presented in Figure 5.12 and to the reaction rate obtained for the activity measurement 1U PME will release 0.54  $\mu\text{M}$  methanol per minute at pH 7.5 at 27 °C. Reaction rate of the blank was subtracted.



**Figure 5.12.** Calibration curve for enzymatic method:  $\Delta A/\Delta t = 0.727 (\pm 0.004) C + 0.004 (\pm 0.006)$ . Reaction rates calculated for 1 min.

According to the performed enzymatic assay PME activity was less than half of the expected values. Possible improvements to the PME assay could include calibration curve construction with pectin instead of methanol as well as adding temperature control device to the experimental setup. Using pectins of exactly known degrees of methylesterification as standards would allow PME to perform its action in the viscous environment, like in case of the pectin sample.

### Conclusions

It was proven that in order to develop PME activity assay two different approaches will be necessary depending on the source of PME. Fungal PME usually has its optimum in the acidic range while plant PME often operates in the neutral pH.

In order to develop fungal PME activity assay either the action of PME should be stopped after preincubation i.e. before EWS is added or the pH of EWS should be lowered to the optimal pH of PME solution, so that the reaction could proceed at its optimum. Second solution has however proven to be impossible due to the enzymes present in EWS and necessity to keep their optimal pH conditions for methanol determination. Fungal PME assay could be therefore further improved if appropriate way of PME inhibition was developed. For plant PME the inhibition seems not to be so crucial as the pH is not changed rapidly when EWS is added.

Another important finding is that, even though the pH of EWS is not optimal for fungal PME the reaction of deesterification proceeds. This is important information for

the development of an automated method for pectin methyl esters where fungal PME could be used. The method is kinetic therefore the reaction does not have to be completed. In the automated method PME is used as a tool for methanol production and experiments described in this chapter prove that it is possible to use fungal PME for this job.

#### **5.2.4. Final ABTS & 4-AAP/phenol methods evaluation**

To finalize the comparative evaluation of ABTS and 4-AAP/phenol methods for methanol determination the blank signals produced by two methods were compared.

##### ***Materials and methods***

45 mM ABTS stock solution was prepared by diluting appropriate amount of ABTS in deionised water. 0.45 and 4.5 ABTS solutions were prepared by diluting appropriate amounts of ABTS stock solution with deionised water. Two EWS solutions were prepared: the first as described on p. 25 and the second without 4-AAP and phenol contained 1.7 U/ml AOX and 66.7 U/ml HRP.

Experimental procedure: ABTS method measurement was performed by adding 1 ml ABTS solution to 0.5 ml deionised water. 1.5 ml of EWS w/o 4-APP and phenol was added and time course measurement software was started at 414 nm right away.

4-AAP method measurements were performed by adding 2.5 ml EWS consisting of 1 U/ml AOX, 40 U/ml HRP, 7.5 mM phenol and 2.5 mM 4-AAP to 0.5 ml deionised water. Time course measurement software was started immediately and reaction rate was followed at 505 nm.

Initially the same concentrations of phenol being the reagent in abundance in 4-AAP method and ABTS were planned to be used taking into account extinction coefficients, stoichiometry and volumes used in the two methods. However due to low ABTS solubility, which turned out to be the limiting step 45 mM ABTS solution and 7.5 mM phenol solution were used.

##### ***Results and discussion***

The results presented in Table 5.10 show a clear superiority of the 4-AAP over ABTS method when it comes to the blank signal. The 4-AAP/phenol method produced no

blank signal. Contrary ABTS method was producing significant signal. This blank signal had no relation to the concentration of ABTS as shown in Table 5.10.

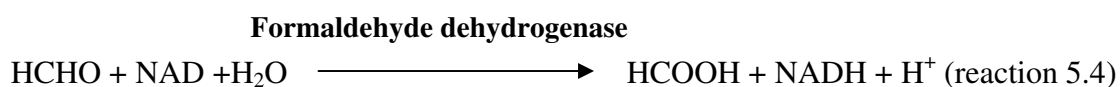
**Table 5.10.** Blank signal for ABTS and 4-AAP methods.

<b>Method</b>	<b>Reaction rate (<math>A \times 10^3 \text{ s}^{-1}</math>) <math>\pm</math> SE</b>
<b>4-AAP</b>	
7.5 mM Phenol	-0.004 $\pm$ 0.002
<b>ABTS</b>	
45 mM ABTS	0.329 $\pm$ 0.003
4.5 mM ABTS	0.264 $\pm$ 0.003
0.45 mM ABTS	0.311 $\pm$ 0.003

Out of the two methods for methanol determination through measuring hydrogen peroxide, 4-AAP/phenol method showed better prospects for automation. That is why it was used for pectin methyl esters determination analyzer described in Chapter 6 of this thesis. As explained before, the blank signal although occasionally observed also with 4-AAP/phenol method, might be related to the autoxidation of alcohol oxidase, which for some reason seems to be more pronounced when ABTS is used.

### 5.3 Insight into the use of formaldehyde

The automation prospects of the method involving formaldehyde measurement after the action of alcohol oxidase (Grsic-Rausch and Rausch, 2004) were investigated. Formaldehyde from reaction 3.1 reacts in reaction 5.4 catalyzed by formaldehyde dehydrogenase (EC 1.2.1.46, FDH) and creation of reduced form of  $\text{NAD}^+$  ( $\text{NADH}$ ) is followed spectrophotometrically at 340 nm.

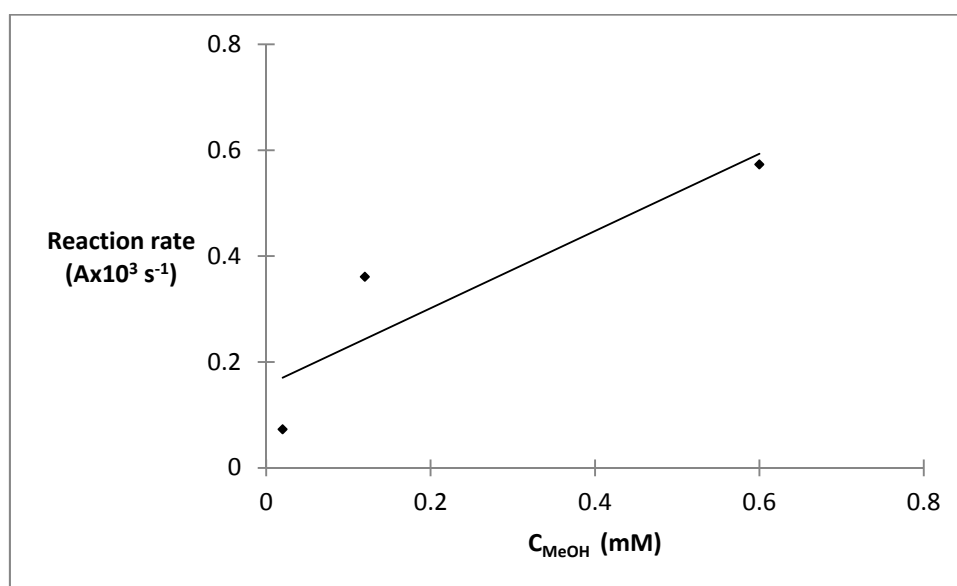


### **Materials and methods**

NAD, formaldehyde dehydrogenase and alcohol oxidase were from Sigma-Aldrich. 0.02, 0.12 and 0.6 mM methanol standards were prepared in 0.1 M phosphate buffer. EWS was prepared by dissolving appropriate amounts of NAD, AOX and FDH in 50 mM phosphate buffer, pH 7.5 obtaining following concentrations: 0.4 mM NAD, 7 U/ml AOX, 0.2 U/ml FDH. Experimental procedure: 250  $\mu$ l of methanol standard was mixed in the cuvette with 2750  $\mu$ l EWS and the reaction rate was measured at 340 nm for 180 s.

### **Results and discussion**

Although results in Figure 5.9 point out that the method could be used for automation it was decided to use at the first stage the 4-AAP/phenol method due to the advantages presented earlier in Chapter 5.



**Figure 5.9.** Calibration data<sup>7</sup> for the methanol determination by formaldehyde measurement:  $\Delta A/\Delta t = 0.7 (\pm 0.4) C + 0.2 (\pm 0.1)$ ,  $r=0.9$ .

<sup>7</sup> Calibration data constructed out of three points are presented to show trends and were not used for sample concentrations calculations.

## 6. Flow analyzer for pectin methyl esters

In this chapter the development of flow analyzer for pectin methyl esters is presented. The chemistry of the analyzer is based on enzymatic hydrolysis of pectin by PME followed by the methanol determination with the 4-AAP/phenol method. Analyzer is based on reverse flow injection (rFI).

### *Materials and methods*

#### Reagents

$0.7 \times 10^{-4}$  phenolophtaleine (PHP) was prepared by dissolving appropriate amount of phenolophtaleine in 0.2 M sodium carbonate buffer, pH 10.5. Enzyme working solution used in the flow and comparison method: 1.2 U/ml AOX and 46 U/ml HRP, 7.5 mM phenol and 2.5 mM 4-aminoanitpyrine in 0.1 M phosphate buffer, pH 7.5. A commercial preparation of a recombinant *Aspergillus oryzae* pectin methylesterase (Novoshape, Novozymes, Bagsvaerd, Denmark), a generous gift from Dr. Hans Sejr Olsen was used as a source of PME. This preparation was filtered before use. According to the product characteristics provided by the producer Novoshape declared activity is 10 U/ml. This preparation was chosen as a source of PME after measuring PME activity in Pectinex 3 XL (Annex 3) and finding out that it was much lower (0.3 U/ml) than in Novoshape.

#### Dispersion coefficient assessment

Dispersion coefficient of the system was measured using  $0.7 \times 10^{-4}$  (PHP) in 0.2 M sodium carbonate buffer, pH 10.5. The PHP was pumped into all tubings and the signal - absorbance was measured ( $A^0$ ). This signal value was divided by the absorbance value obtained when PHP was injected into buffer solution (A). Dispersion coefficient defined as ratio  $A^0/A$  was equal to 1.4. Based on this value concentrations of enzymes in EWS were adjusted in relation to manual experiments described in Chapter 5.

### Standards and samples

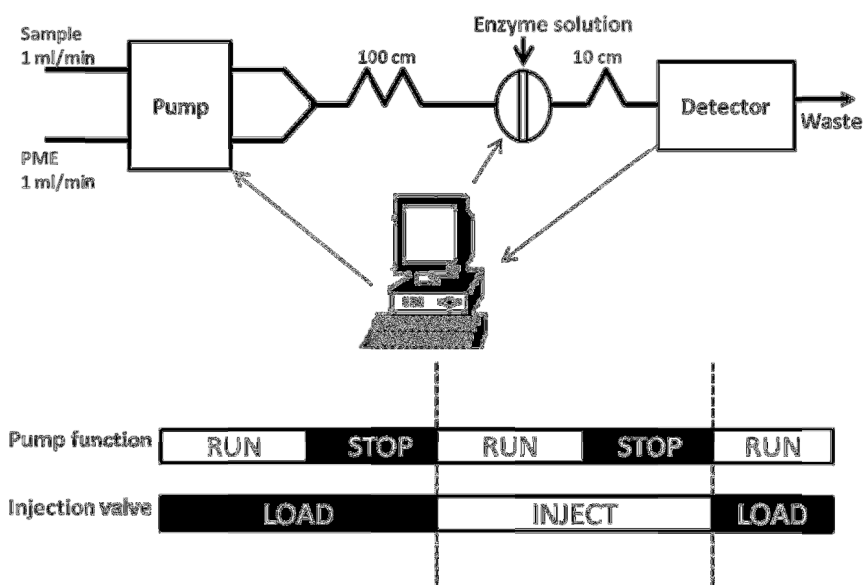
A stock solution of 0.25 g 100 ml<sup>-1</sup> pectin equivalent to 7.2 mM methanol concentration was prepared in deionizer water using HM citrus pectin of 69.5 % degree of esterification. Dilutions 0.02, 0.05, 0.09, 0.12, 0.14, 0.18, 0.22 and 0.25 g 100 ml<sup>-1</sup> corresponding to: 0.49, 1.4, 2.6, 3.4, 4., 5.2, 6.3 and 7.2 mM methanol were prepared from the stock solution. Methanol concentrations calculations were based on degree of esterification and galacturonic acid content measurements. Methanol standards of 0.25, 0.49, 0.74, 0.99, 1.24, 1.48 and 1.73 mM for comparison method were prepared in deionized water and stored at -20°C. The standards were thawed just before measurement. Methanol standards used for the kinetic study were prepared in 0.1 M phosphate buffer, pH 7.5. Pectins were donated by CP Kelco ApS (Lille Skensved, Denmark) and by Dr. Karen Marie Søndergaard, DuPont NHIB Denmark ApS.

### Comparison method

For comparison method, pectin saponification and neutralization was performed as described by Klavons and Bennett (1986). The absorbance was measured exactly 10 minutes after EWS addition. EWS reagent and sample blank were measured and subtracted.

### Flow injection analyzer

The flow injection analyzer is depicted in Figure 6.1. Pectin is mixed in the first mixing coil with PME. Methanol is released as a result of action of the enzyme on methyl esterified groups of pectin (reaction 5.3). EWS is injected further downstream. Methanol is oxidized by AOX releasing formaldehyde and hydrogen peroxide (reaction 3.1). This reaction is coupled to HRP catalyzed reaction, which gives the colored product 4-N-(p-benzoquinoneimine)-antipyrine (reaction 5.2). Reaction rate is proportional to methanol concentration and it is followed by the detector Ocean Optics USB 2000+ spectrophotometer.



*Figure 6.1. Manifold scheme and timing sequence of the analyzer.*

The analyzer is managed by a lab written program developed in LabVIEW which provides for data acquisition from the detector and control of the pump and injection valve. The program also controls the timing of the analyzer, as presented in Figure 6.1, displays raw data in the screen and stores on the hard disc. Dedicated functions have been developed for controlling the load and inject positions of the Vici Valco injection valve and the stop and run positions of the Gilson Minipuls 3 peristaltic pump. Program runs on a personal computer incorporating the PCI-1760U Advantech card - used for controlling the peristaltic pump and the injection valve. Data acquisition from the detector was through the USB port controlled through LabVIEW function developed.

First, the pump is stopped and the mixture of the sample and PME is trapped in the first mixing coil. One minute is allowed for PME catalyzed reaction (reaction 5.3) to proceed and then the pump is started and EWS is injected. Nine seconds are allowed for the reaction mixture to reach the flow cell. Then the pump stops for the second time for five minutes to monitor the reaction 5.2. If needed, the operator has the choice to flush the system between successive measurements. PTFE tubing with 0.8 mm I.D. was used throughout. Decision to use the second stop flow was based on the comparison of the signal for stopped flow and continuous flow measurements using PME commercial preparation of different dilutions. PME commercial preparation



dilutions from 1:1, 1:4 and 1:6 v/v were used and pectin solutions 0.2, 0.3 and 0.4 % w/v.

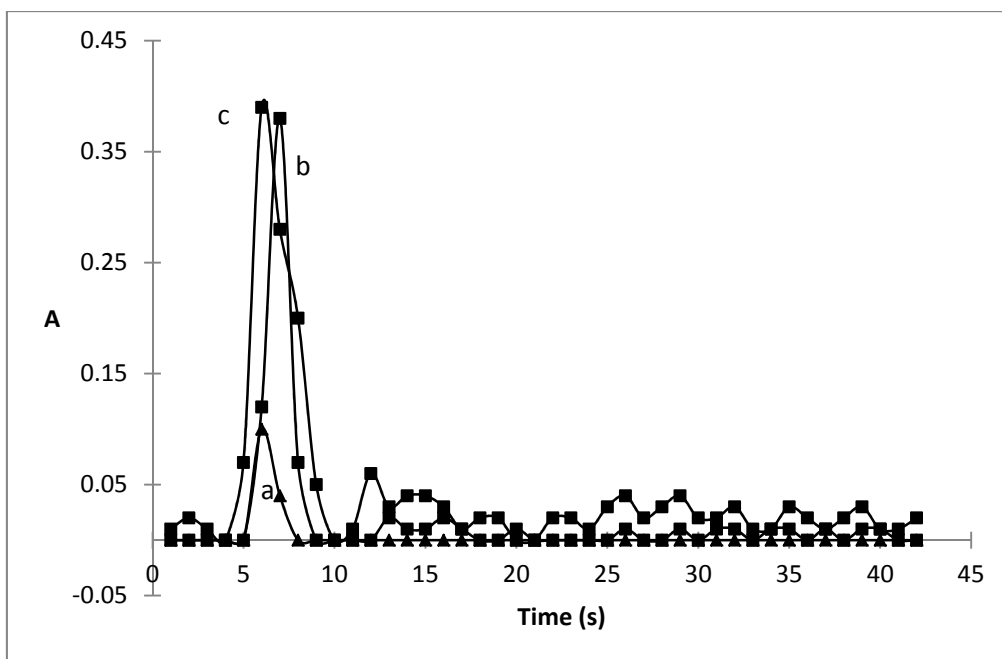
#### Treatment of data

The LabVIEW program acquires the whole spectrum: 189 - 1037 nm, every second. This creates a time-dependant data matrix. A separate, lab written program was used for extracting data at 505 nm. The program was built using Visual Basic and gets input from the file created by the LabVIEW program.

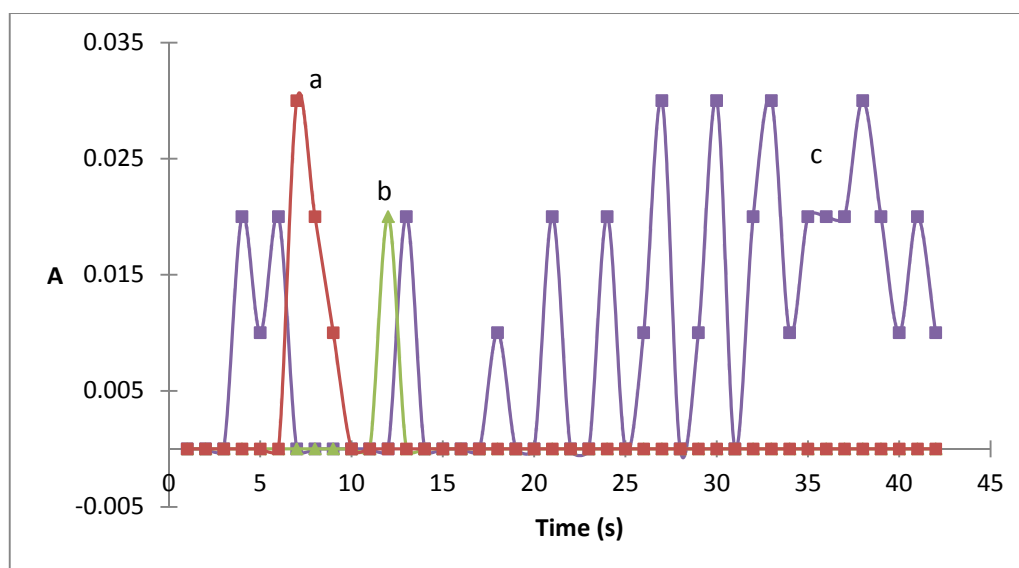
Reaction rates were calculated by regression analysis using the significant part of the data for each measurement.

#### ***Results and discussion***

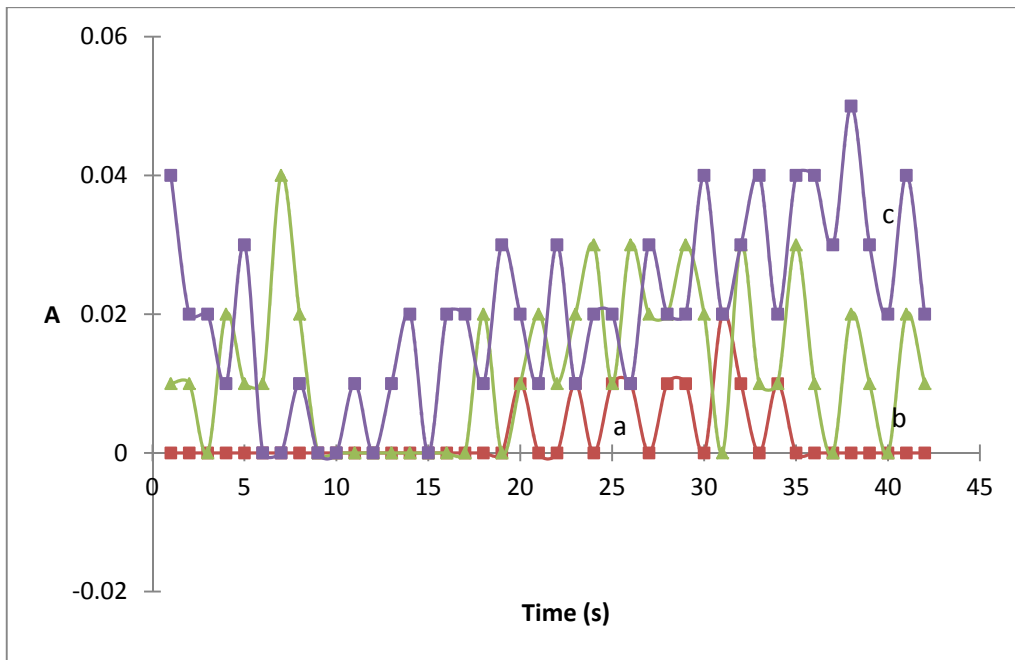
Decision to use stop flow was preceded by a set of measurements and trends comparison of stop flow and continuous flow measurements for different pectin concentrations using PME commercial preparation of different dilutions (Figures 6.2-6.7). Two trends can be observed from the series of measurements presented in Figures 6.2-6.7; i) stop flow measurements produce higher signals than continuous flow measurements, ii) the signals from higher dilutions of PME commercial preparation (1:4 and 1:6) are higher than signal produced by PME commercial preparation 1:1. Based on this results it was decided to use stop-flow for monitoring reaction 5.2. Additionally, further investigation of the PME commercial preparation dilution on the signal was performed and is described in the following subsection.



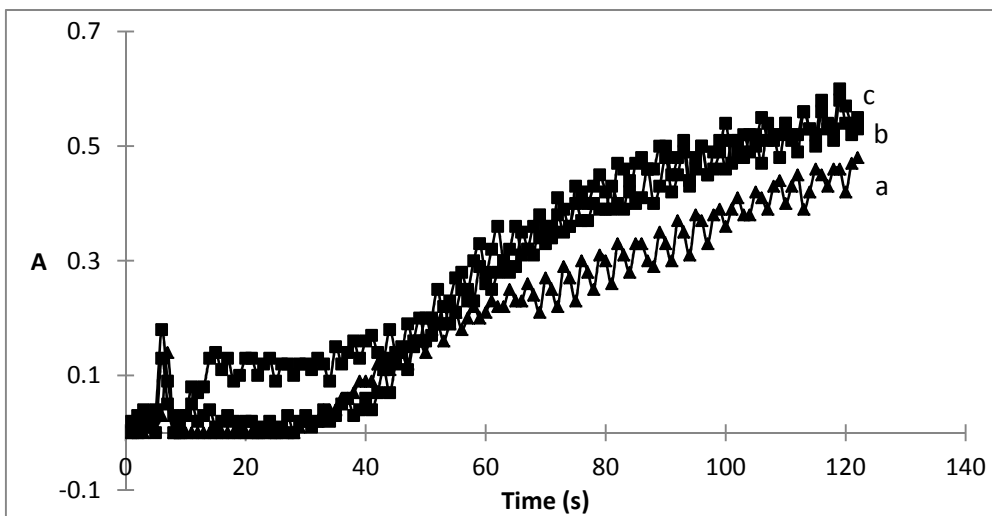
**Figure 6.2.** Flow injection trends for measurement performed with continuous flow mode for different pectin concentrations: a) 0.2, b) 0.3 and c) 0.4 % w/v. Dilution of commercial pectin methylesterase: 1:2 v/v.



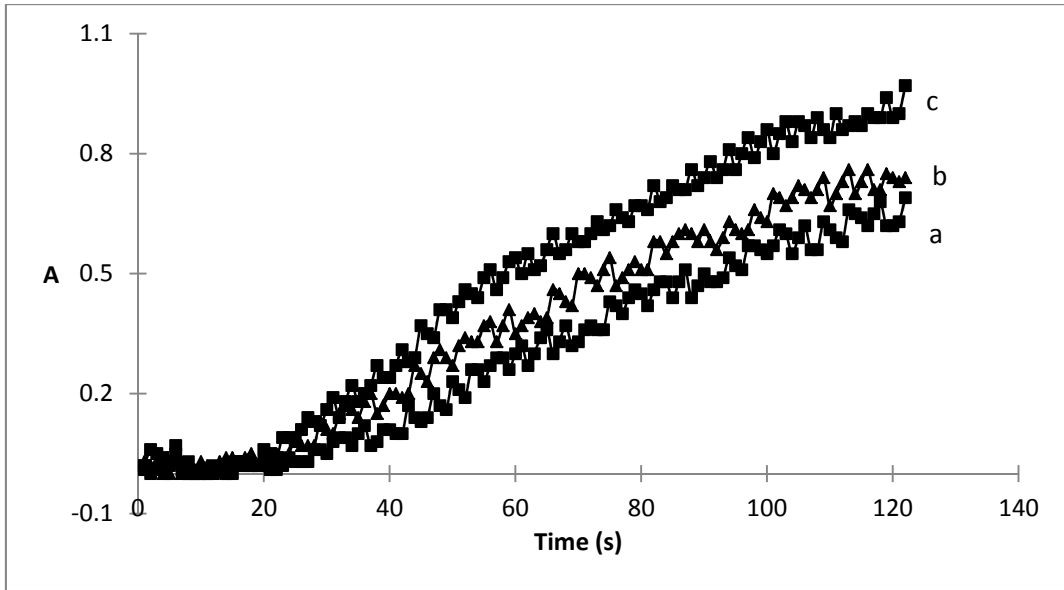
**Figure 6.3.** Measurement performed with continuous flow different pectin concentrations: a) 0.2, b) 0.3 and c) 0.4 % w/v. Dilution of commercial pectin methylesterase: 1:4 v/v.



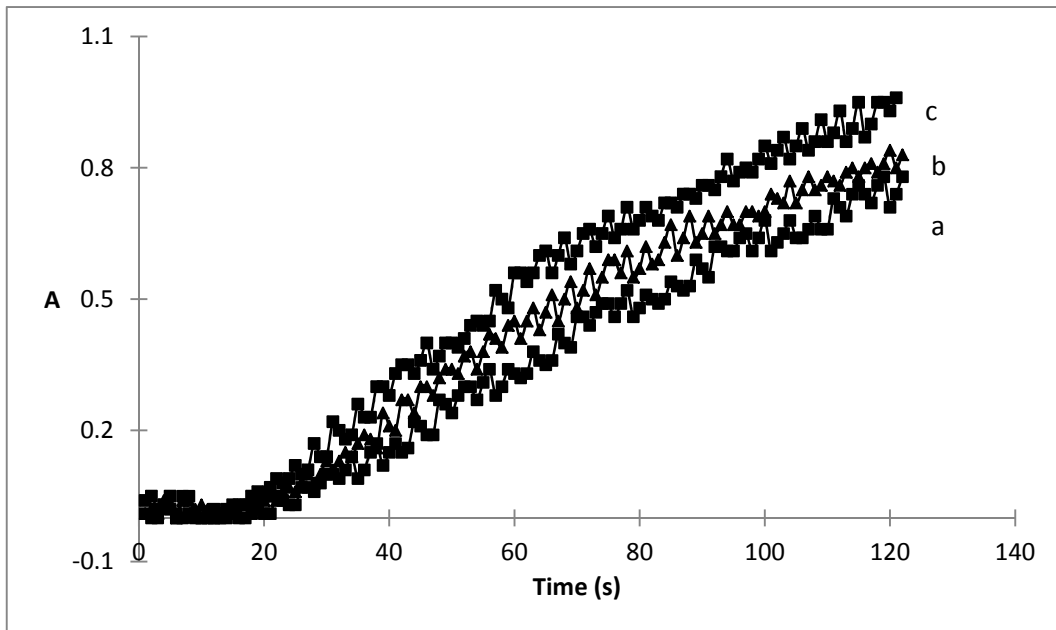
**Figure 6.4.** Measurement performed with continuous flow for different pectin concentrations: a) 0.2, b) 0.3 and c) 0.4 % w/v. Dilution of commercial pectin methylesterase: 1:6 v/v.



**Figure 6.5.** Flow injection stopped-flow measurements after stopping the flow performed for following pectin concentrations: a) 0.2, b) 0.3 and c) 0.4 % w/v. Dilution of commercial pectin methylesterase: 1:2 v/v.



**Figure 6.6.** Flow injection stopped-flow measurements for different pectin concentrations: a) 0.2, b) 0.3 and c) 0.4 % w/v. Dilution of commercial pectin methylesterase: 1:4 v/v.



**Figure 6.7.** Flow injection stopped-flow measurements for different pectin concentrations: a) 0.2, b) 0.3 and c) 0.4 % w/v. Dilution of commercial pectin methylesterase: 1:6 v/v.

### Flow method optimization

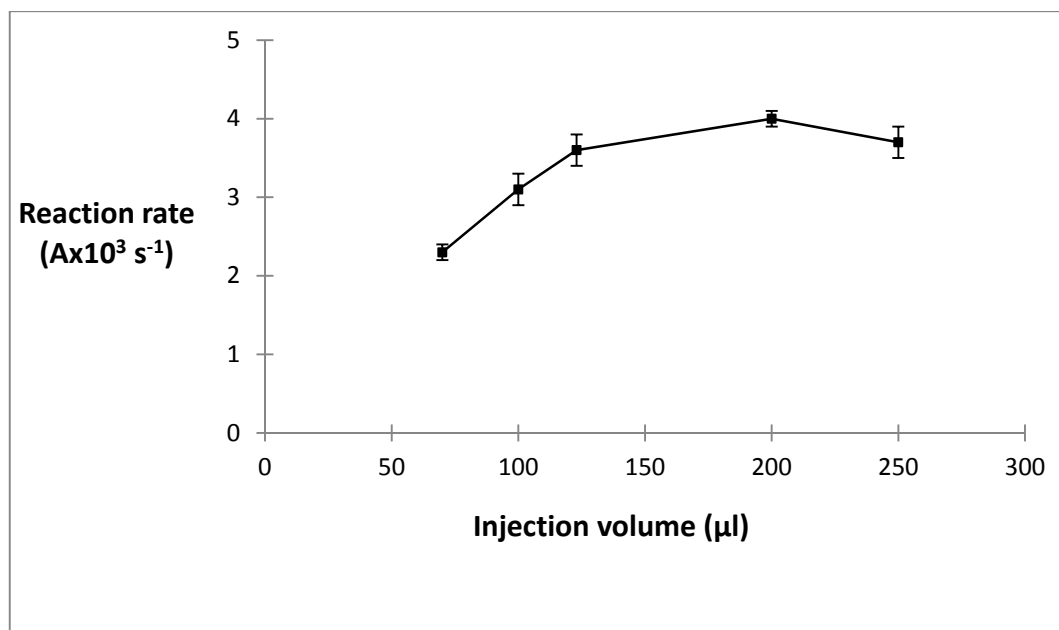
Univariate optimization was performed for the following parameters: i) PME commercial preparation dilution, ii) total flow rate, iii) injection volume, iv) first stop time in Figure 6.1, that is preincubation time - the time allowed for methanol production (reaction 5.3), v) time allowed for the reaction mixture to reach the flow cell that is the second run time in Figure 6.1. Following parameter ranges were selected for the univariate optimization: total flow rate from 1 to 4 ml min<sup>-1</sup>, injection volume from 70 to 250 µl, preincubation time from 2 to 60 s and second run time from 3 to 11 s. The ranges were selected based on the limitations of fluidic systems.

The effect of dilution of the PME preparation was tested by diluting filtered Novoshape solution in deionized water up to 1:100. High PME activities increase the blank that reaches sample signal. This is probably due to glycerol contained in Novoshape as a stabilizer. AOX is not specific towards methanol and although it has higher affinity towards methanol, it probably also oxidizes glycerol. This is further supported by the observation that the signal of the blank increases along Novoshape concentration. To minimize reagent blank, higher Novoshape dilutions were assessed. It should be noted that, as expected, lower PME activities result in lower analytical signal. That is, although dilutions 1:60 and 1:100 show high signal to blank ratios (Table 6.1) they were rejected on the basis of 12 and 22 % lower net analytical signal than for 1:20 dilution which was finally selected.

**Table 6.1.** Effect of pectin methylesterase commercial preparation activity on the analytical signal.

<b>Pectinesterase dilution (v/v)</b>	<b>Ratio signal/blank</b>
1:3	1.4
1:5	1.6
1:7	2.4
1:10	3.1
1:20	11.3
1:60	27.6
1:100	35.2

The range of total flow rate considered for optimization was 1-4 ml min<sup>-1</sup>. A total flow rate of 2 ml min<sup>-1</sup> resulted in the best mixing of reagents giving the highest analytical signal. Figure 6.8 shows that signal increases along increase of injected EWS volume in the range 70-123 µl. 123 µl was chosen as further increase up to 250 µl does not affect significantly the analytical signal.



**Figure 6.8** Injection volume effect on the reaction rate using pectin standard corresponding to 5.7 mM methanol.

Preincubation time is related to PME action influencing methanol production in the first mixing coil. Table 6.2 presents the effect of preincubation time on reaction rate in the range of 2 to 60 s. As expected signal increases along analytical preincubation time. 60 s were chosen for the developed method as a tradeoff between sensitivity and analytical time. To shorten development time, 10 s preincubation time was used throughout optimization.

A second run time used for allowing the reaction mixture to reach the flow cell (depicted in Figure 6.1) was varied from 3 to 11 s. The analytical signal increases along time, the maximum being observed at 9 s, and then it decreases.

**Table 6.2.** Preincubation time effect on the reaction rate using pectin standard corresponding to 5.7 mM methyl esters.

<b>Preincubation time (s)</b>	<b>Reaction rate <math>\pm</math> SE (<math>A \times 10^3 \text{ s}^{-1}</math>)</b>
2.0	$2.4 \pm 0.2$
5.0	$3.8 \pm 0.1$
10.0	$4.9 \pm 0.1$
20.0	$5.6 \pm 0.1$
30.0	$6.4 \pm 0.1$
60.0	$6.9 \pm 0.1$

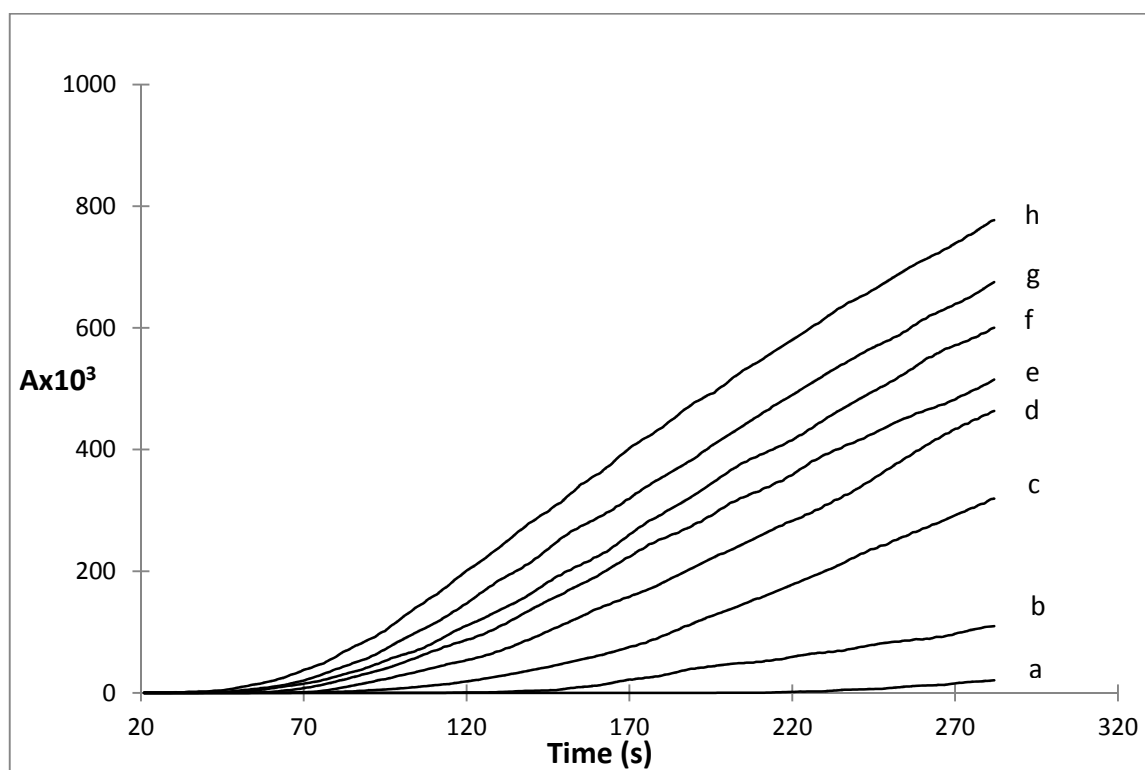
Mixing coil after the injection valve facilitates mixing of EWS with sample/PME stream. To assure that the reaction mixture is rapidly transported for monitoring in the flow cell, coil length should be the smallest possible. It should be noted that coils dampen peristaltic pump pulsations resulting in increased precision. Therefore and also due to the fact that the reaction 5.2 is fast (Vasilarou and Georgiou, 2000) a very short mixing coil, i.e. 10 cm was selected.

Particular attention has to be paid to avoid carry over between samples and to diminish the effect of absorption/desorption processes on the manifold. These phenomena are particularly exaggerated in case of viscous samples such as pectin. Readings for the first daily calibration curve differ significantly from the following. First reading for 1.4 mM methanol was  $1.03 \pm 0.03$  followed by two subsequent analyses of the standard corresponding to  $1.81 \pm 0.03$  and  $1.79 \pm 0.03 A \times 10^3 \text{ s}^{-1}$ . This was solved by allowing 8 standard injections before actual measurements on startup, improving precision of 10 consecutive injections to 5.3 % RSD.

Typical readings acquired during the second stop of the pump illustrating the linearity of the measurements are shown in Figure 6.9. Presented data are smoothed by

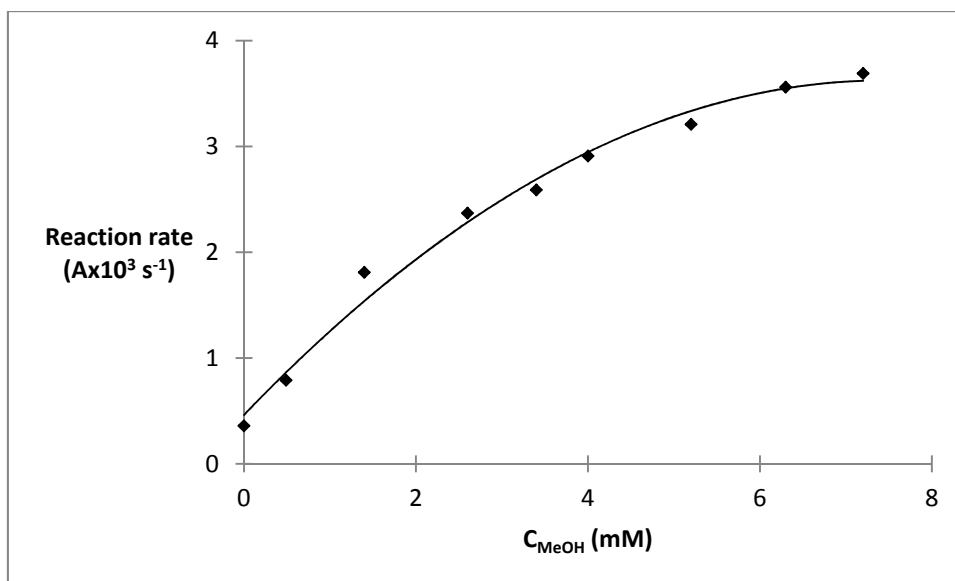


substituting values with the mean resulting from the previous 20 and following 20 readings.



**Figure 6.9.** Stopped flow injection peaks for pectin calibration standards corresponding to the following methanol concentrations: a) 0, b) 0.4, c) 1.4, d) 2.6, e) 3.4, f) 4.0, g) 5.2, h) 6.3 and i) 7.2 mM.

The calibration curve was: reaction rate ( $A \times 10^3 \text{ s}^{-1}$ ) =  $(-0.0569) C^2 + 0.8487 C + 0.4622$ ,  $r=0.994$  (Figure 6.10).



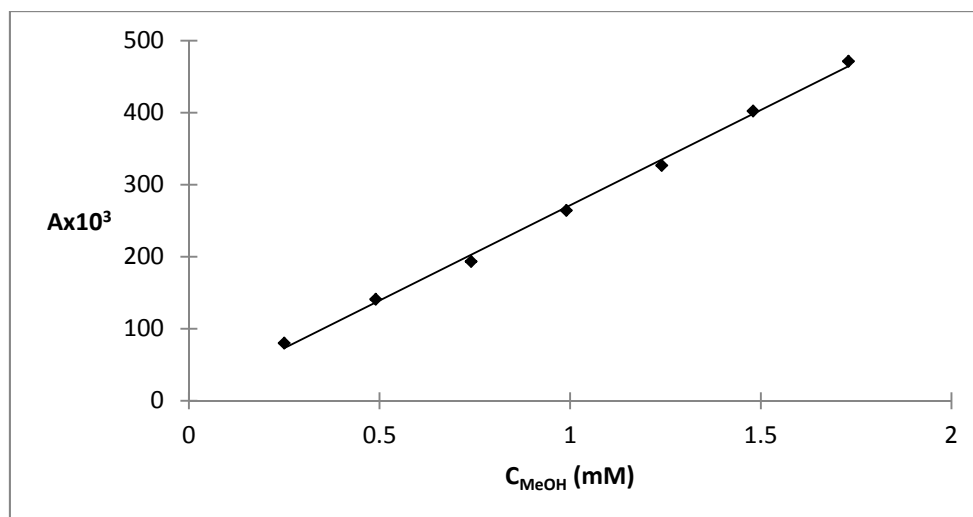
**Figure 6.10.** Calibration curve for the automated method.

Results from the analysis of samples in comparison to those acquired with the manual method are shown in Table 6.3.

**Table 6.3:** Comparison between the automated and the manual method.

Sample	Methanol content (mM)	
	automated method	manual method
1	4.0	4.4
2	7.5	5.9
3	5.8	6.2
4	2.0	3.8

The detection limit calculated as  $LOD = 3.3 \times S_{intercept}/slope$  was found to be 1.47 mM. The analysis rate of the developed method is 7 samples  $h^{-1}$ . Analysis time is shorter than in manual method where at least 30 minutes are required for saponification. Calibration curve for comparison method is presented in Figure 6.11.



**Figure 6.11.** Calibration curve for comparison method:  $\Delta A/\Delta t$  ( $A \times 10^3 s^{-1}$ ) =  $264 (\pm 6) C + 7 (\pm 7)$ ,  $r=0.999$ .

To verify that the proposed method is equivalent to manual method a paired t-test was performed resulting in  $t_{\text{experimental}}$  0.357 when  $t_{\text{theoretical}}$  is 3.18 for 3 d.f. at confidence level 95 %, proving that there is no significant difference between the two methods. For HM pectin the difference between two methods was insignificant, while for LM it was higher (Table 6.3). This is probably due to the lower hydrolysis rate of LM pectins resulting from their lower methyl ester content. A remedy is to match samples with standards, using LM pectins for calibration when analyzing LM pectins. It is interesting to note that both reactions, catalyzed by PME and AOX, do not come to an end. Moreover, physical mixing of the injected EWS cocktail is also kinetic in nature, not coming to the steady state during the analytical run. These are clear differences from the manual method giving the opportunity of lower analysis time but also the challenge for selecting appropriate calibration standards.

In kinetic methods of analysis only the initial fraction of the reaction is monitored providing a fast alternative to time-consuming end point methods. Analytical parameter is not the absolute value of the signal but the rate of its change. This eliminates end-point problems due to sample and/or reagent blank. With kinetic methods of analysis, interferences from slow reactions are insignificant while those resulting from fast reactions are eliminated by a short preincubation step where interfering species are consumed (Vasilarou and Georgiou, 2000).

In order to increase the analysis rate and decrease the detection limit, the analyzer could be coupled to a more sensitive detection technique i.e. chemiluminescence, with

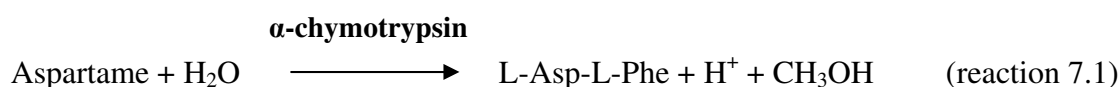
which concentrations as low as 10 nM can be measured (Vasiliou et al. 2007). Use of chemiluminescence would allow higher dilution of samples and therefore the washing step could be eliminated and monitoring time shortened.

## 7. Flow analyzer for aspartame determination

### 7.1. Kinetic aspartame determination

Kinetic method for aspartame determination was the first step in the development of the automated method for aspartame determination described in later sections of this chapter.

Kinetic aspartame determination is based on enzymatic hydrolysis of aspartame by  $\alpha$ -chymotrypsin (reaction 7.1) in which methanol is one of the products.



Further steps are based on the theory described in the Chapter 3, Section 3.1 and Chapter 5, Section 5.2. Methanol concentration is determined by measuring hydrogen peroxide concentration after methanol oxidation by alcohol oxidase (reaction 3.1). Methanol oxidation is coupled to a peroxidase catalyzed reaction (reaction 5.2) in which a colored product 4-*N*-(*p*-benzoquinoneimine)-antipyrine is formed. The formation of the product is followed spectrophotometrically.

#### *Materials and methods*

Aspartame and  $\alpha$ -CHY were from Sigma-Aldrich. All reagents were analytical grade. 33.3 mM aspartame stock solution was prepared by dissolving the appropriate amount of aspartame in 0.1 M phosphate buffer, pH 7.4. 5.00, 10.00, 20.00, 30.00 mM calibration standard aspartame solutions and 1.00, 2.00, 7.00, 15.00, 25.00, 35.00 mM aspartame solutions used as samples were prepared by appropriate aspartame stock solution dilution in 0.1 M phosphate buffer, pH 7.4. Stock solution of  $\alpha$ -CHY (80 U/ml) was prepared by dissolving appropriate amount in deionized water. Enzyme working solution was prepared as described in Chapter 5.2.

Experimental procedure: 0.5 mL of sample was placed in a 3 mL quartz cuvette in the spectrophotometer. 150  $\mu$ l (12 U) of  $\alpha$ -CHY stock solution was pipetted into cuvette. After 2 min preincubation during which hydrolysis reaction (reaction 7.1) is proceeding, 2.5 mL of EWS was added. The software for kinetic measurement of Jasco V-550 spectrophotometer was started at the wavelength 505 nm. 0.1 M

phosphate buffer, pH 7.4 was used as blank. Precision of the method was determined by measuring ten times the reaction rate obtained with 15 mM aspartame solution.

The assay was optimized for:

- ✓  $\alpha$ -CHY activity,
- ✓ preincubation time and
- ✓ temperature.

The effect of  $\alpha$ -CHY activity was investigated using 33.3 aspartame stock solution and 2 min preincubation. The effect of preincubation time was examined using 33.3 mM aspartame stock solution and 12 U  $\alpha$ -CHY. Temperature effect was investigated by adjusting temperature of reaction 7.1 in a water bath. The experimental procedure described before was followed otherwise.

## ***Results and discussion***

### Optimization of $\alpha$ -CHY activity

As presented in Table 7.1, analytical signal increases along  $\alpha$ -CHY activity. However, the slope value increase was just 7.2 % as  $\alpha$ -CHY activity increased from 12 to 32 U. 12 U  $\alpha$ -CHY was selected as this analytical signal increase is small and does not justify the increase in the cost of the enzyme.

*Table 7. 1. Effect of  $\alpha$ -CHY activity increase.*

<b><math>\alpha</math>- chymotrypsin activity (U)</b>	<b>Aspartame slope (<math>A \times 10^3 \text{ s}^{-1}</math>) <math>\pm</math> SE</b>	<b>Correlation coefficient, <math>R^2</math></b>	<b>Blank slope (<math>A \times 10^3 \text{ s}^{-1}</math>) <math>\pm</math> SE</b>
<b>8</b>	4.07 $\pm$ 0.02	0.995	-0.014 $\pm$ 0.002
<b>12</b>	4.40 $\pm$ 0.02	0.996	-0.003 $\pm$ 0.002
<b>16</b>	4.58 $\pm$ 0.02	0.996	0.002 $\pm$ 0.002
<b>20</b>	4.65 $\pm$ 0.02	0.997	-0.004 $\pm$ 0.002
<b>24</b>	4.67 $\pm$ 0.02	0.997	0.009 $\pm$ 0.002
<b>28</b>	4.74 $\pm$ 0.02	0.997	0.001 $\pm$ 0.002
<b>32</b>	4.75 $\pm$ 0.02	0.997	0.000 $\pm$ 0.002

#### Optimization of pre-incubation time

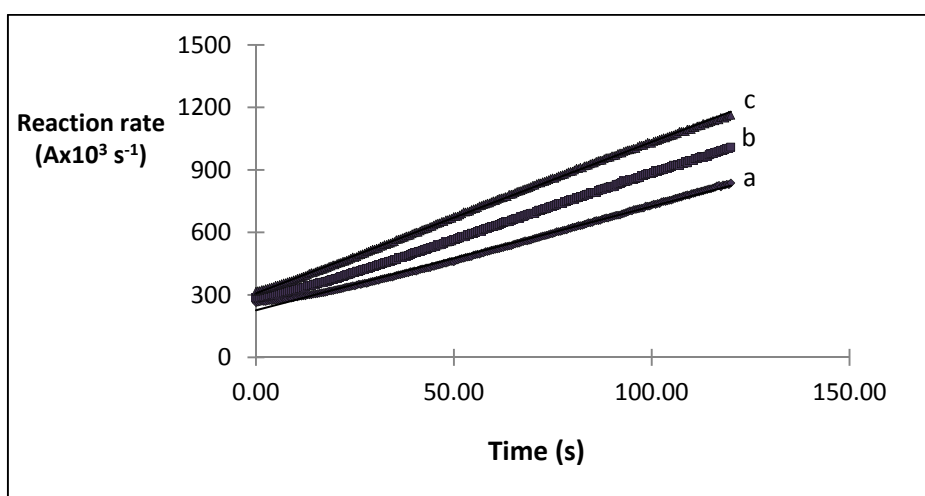
In reaction 7.1, aspartame is cleaved by  $\alpha$ -chymotrypsin to L-Asp-L-Phe and methanol. The goal of this optimization step was to determine the optimum time for this reaction. Results in Table 7.2 show the analytical signal increase was just 7.4 % as preincubation time increased from 2 to 14 minutes. In this respect, 2 min pre-incubation time was selected.

**Table 7.2.** Effect of pre-incubation time.

<b>Pre-incubation time (min)</b>	<b>Aspartame slope (<math>A \times 10^3 s^{-1}</math>) <math>\pm</math> SE</b>	<b>Correlation coefficient, <math>R^2</math></b>	<b>Blank slope (<math>A \times 10^3 s^{-1}</math>) <math>\pm</math> SE</b>
<b>2</b>	$4.72 \pm 0.02$	0.997	$0.015 \pm 0.002$
<b>6</b>	$4.85 \pm 0.02$	0.997	$0.006 \pm 0.002$
<b>10</b>	$4.97 \pm 0.02$	0.997	$0.008 \pm 0.002$
<b>14</b>	$5.07 \pm 0.02$	0.997	$0.011 \pm 0.002$

Temperature effect

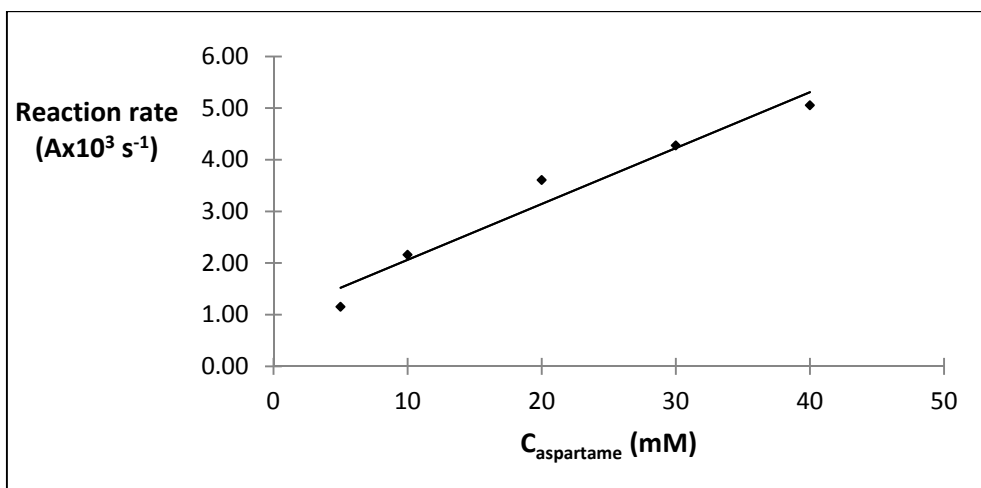
As expected, the reaction rate increases along temperature increase (Figure 7.1). The reaction rate increases.



**Figure 7.1** Temperature influence on reaction rate: a) 18, b) 23 and c) 28°C.

Calibration curve prepared using optimized parameters had following calibration equation:  $\Delta A/\Delta t = (A \times 10^3 s^{-1}) = (0.11 \pm 0.01) C \text{ (mM)} + (0.98 \pm 0.32)$ ,  $R^2 = 0.96$ . It is presented in Figure 7.2.





*Figure 7.2 Calibration curve.*

### Precision

Precision data is shown in Table 7.3. Results for 10 consecutive measurements of the 15 mM aspartame solution are presented. Mean reaction rate ( $\pm$  SE) was  $2.98 \pm 0.087$   $\text{Ax}10^3 \text{ s}^{-1}$ .

*Table 7.3. Precision of the method.*

<b>Measurement no.</b>	<b>Reaction rate (<math>A \times 10^3 \text{ s}^{-1}</math>) <math>\pm</math> SE</b>	<b>Correlation coefficient, <math>R^2</math></b>
<b>1</b>	2.928 $\pm$ 0.009	0.998
<b>2</b>	2.925 $\pm$ 0.008	0.998
<b>3</b>	2.845 $\pm$ 0.008	0.998
<b>4</b>	2.906 $\pm$ 0.009	0.997
<b>5</b>	3.087 $\pm$ 0.007	0.999
<b>6</b>	3.039 $\pm$ 0.009	0.998
<b>7</b>	2.936 $\pm$ 0.008	0.998
<b>8</b>	3.053 $\pm$ 0.008	0.998
<b>9</b>	3.105 $\pm$ 0.009	0.998
<b>10</b>	2.952 $\pm$ 0.008	0.998

Standard solution analysis

As shown in Table 7.4, low concentrations of aspartame are difficult to detect with the developed method. The signal is too low, and there is no measurable increase in the reaction rate.

**Table 7.4.** Analysis of standard solutions.

<b>Taken (mM)</b>	<b>Found (mM)</b>
1.00	ND <sup>8</sup>
2.00	ND
7.00	5.75
15.00	19.24
25.00	30.14
35.00	36.65

Results from the Table 7.4 are explained by the detection limit found to be 9.6 mM. The detection limit was calculated using following equation:  $LOD = 3.3 \times S_b/a$ , where  $S_b$  is the standard error of the intercept and  $a$  is the slope. Results clearly indicate possibilities for further work towards lowering the detection limit using a more sensitive technique, such as fluorimetry or chemiluminescence.

#### Determination of aspartame in real food samples

After basic development and optimization of the method, an attempt was made to determine the aspartame concentration in Coca-Cola Zero and Canderel sweetener pills. Main problem that occurred was low concentration of aspartame in the samples. It was hard to obtain accurate signal as the aspartame concentration was close to the detection limit. The concentration of aspartame in diet drinks is expected to be around 2 mM. Proposed method requires relatively high aspartame concentration in a sample, in order to get the measurable response, as can be seen from analysis of standard solutions (Table 7.4). Additionally, in order to get rid of the interference of caramel color of Coca-Cola it is necessary to dilute samples at 1:5. In this way, aspartame concentration is even lower, so it cannot be measured spectrophotometrically. Preparation of Canderel solution of aspartame concentration close to the detection

---

<sup>8</sup> Not detected

limit requires dissolution of 7 Canderel pills in 20 mL of deionized water making the procedure ineffective.

The proposed method shows good results in samples containing high aspartame concentrations. Since, most beverages do not contain high aspartame content, method needs further work through enhancing the sensitivity of the detection. For that purpose, chemiluminescence as method for detection was chosen for further method development and improvement.

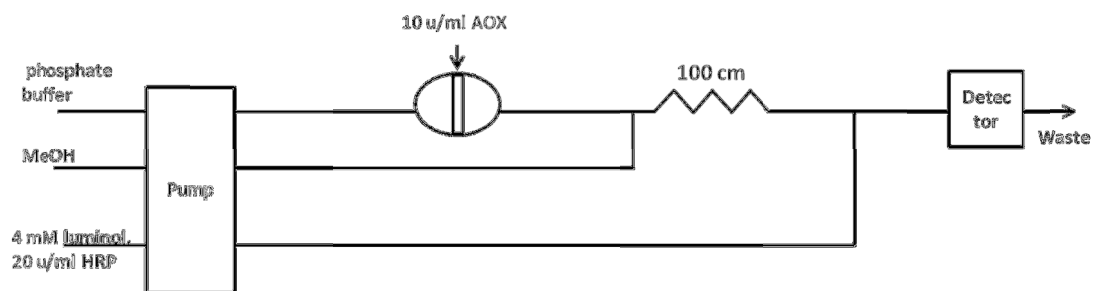
## **7.2. Analyzer development**

### Solutions

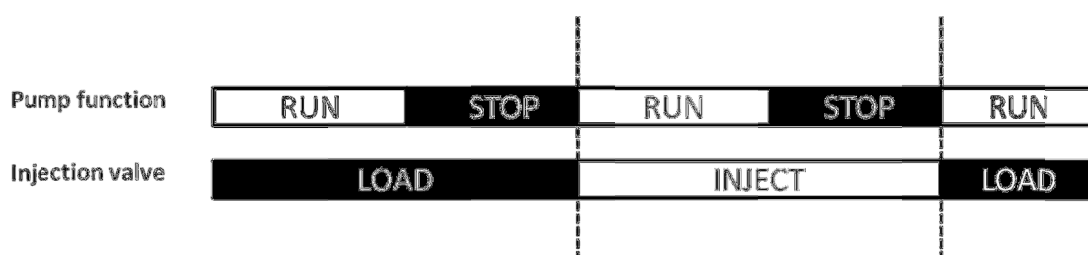
Mixed 4 mM luminol and 20 U/ml HRP solution was prepared by dissolving appropriate amounts of luminol and HRP in 0.2 M sodium carbonate buffer, pH 10.1. 10 U/ml AOX solution was prepared by dissolving appropriate amount of AOX in phosphate buffer, pH 7.5. 0.5, 2.0, 4.0, 6.0 and 8.0 mM calibration methanol standards were prepared in RO water. Luminol, aspartame,  $\alpha$ -CHY, AOX and HRP were from Sigma Aldrich. All other reagents were analytical grade.

### Manifold

Manifold is shown in Figure 7.3. It consists of three lines: first with phosphate buffer, to which AOX is injected, second with methanol and third with mixed solution of 4 mM luminol and 20 U/ml HRP. All lines use flow rates of 0.8 ml/min. After injection, when AOX reaches the center of 100 cm mixing coil the pump is stopped for 1 min under command of the homemade programme. Timing sequence of the analyzer is presented in Figure 7.4. Calibration curves presented in the “Results and discussion” section are based on peak heights.

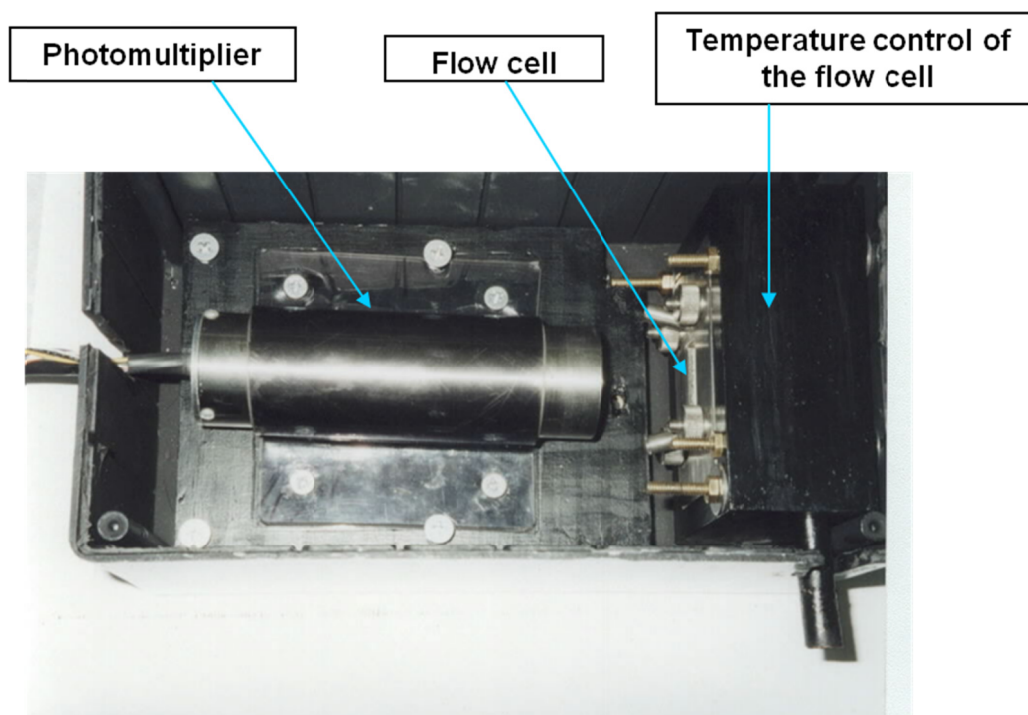


*Figure 7.3. Manifold for aspartame determination.*



*Figure 7.4. Timing sequence of the manifold presented in Figure 7.3.*

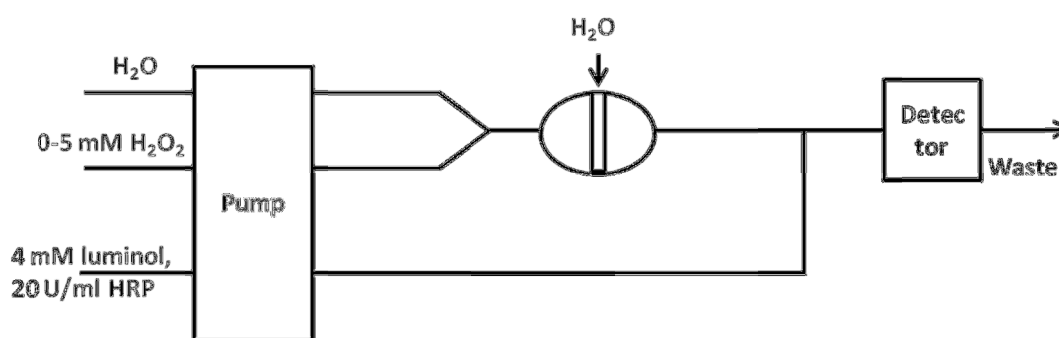
Figure 7.5 presents the homemade chemiluminometer detector used throughout the study.



*Figure 7.5. Homemade chemiluminometer detector used throughout the study.*

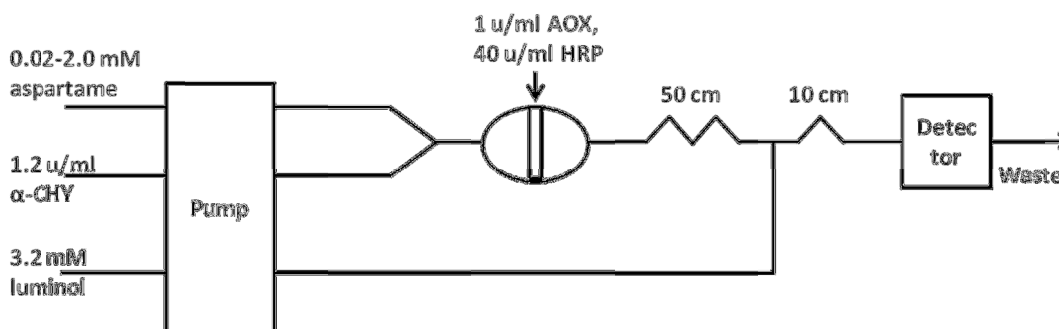
## Preliminary manifolds

In order to efficiently develop the analyzer shown in Figure 7.3 different enzymatic actions were separated. Figure 7.6 shows a preliminary manifold where hydrogen peroxide is mixed with luminol and HRP solution. For the preliminary manifold presented in Figure 7.6, 2.5 and 5 mM H<sub>2</sub>O<sub>2</sub> was prepared by diluting appropriate amount of 30 % H<sub>2</sub>O<sub>2</sub> in 0.2 potassium phosphate buffer, pH 7.2. Mixed solution of 4 mM luminol and 20 U/ml HRP was prepared by diluting appropriate amounts of the reagents in 0.2 M carbonate buffer, pH 10.1 (Moon et al., 2012). Flow rate of each line was 5.2 ml/min.



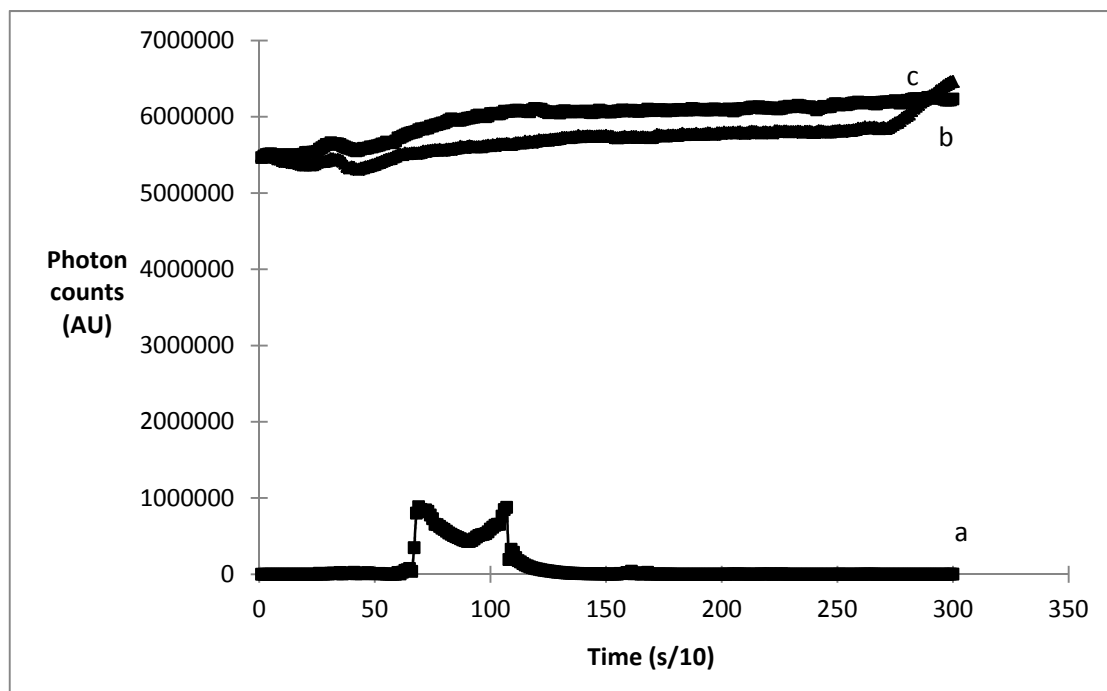
*Figure 7.6. Manifold used for the preliminary study.*

In order to develop a fully automated method, the automation of all steps (reactions 7.1, 3.1 and 5.2) was tried using manifold in Figure 7.7. AOX and HRP were injected in the reverse mode to lower the consumption of the rather high-cost enzymes, while  $\alpha$ -CHY is chosen to flow continuously as its cost is lower. Unfortunately the use of mixed solution containing all three enzymes was excluded as  $\alpha$ -CHY should lead the sequence, so that methanol is build up to be consumed subsequently by the injected AOX that creates hydrogen peroxide. Each line had the flow rate of 5.2 ml/min.



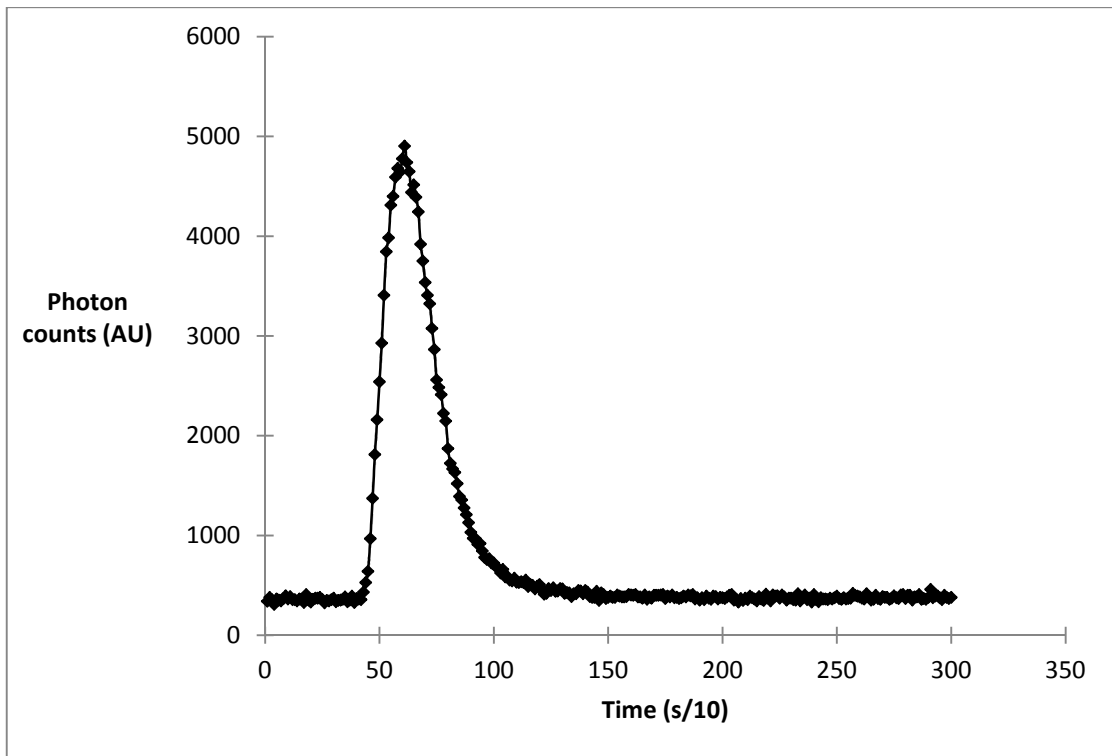
*Figure 7.7. Manifold used for initial measurements with aspartame.*

As presented in Figure 7.8 the detector works properly and high signals of around 6000000 photon counts were observed. The lack of mixing coils in the preliminary manifold (Fig 7.6) is sufficient explanation that there is no clear differentiation between the signals for 2.5 mM and 5 mM hydrogen peroxide.

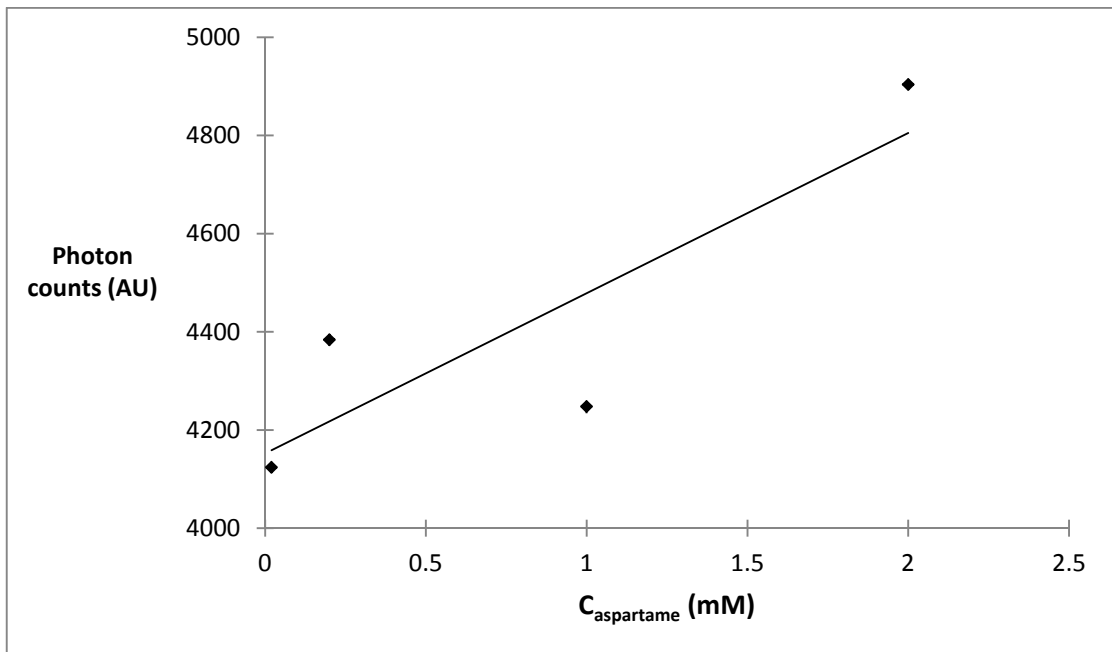


**Figure 7.8.** Signal observed for different hydrogen peroxide concentration when using manifold presented in Figure 7.6. Hydrogen peroxide concentrations: a) 0, b) 2.5 and c) 5 mM.

Figure 7.9 shows a resulting peak from 2 mM aspartame obtained using the manifold in Figure 7.7. Calibration curve for aspartame concentrations 0.02-2 mM is shown in Figure 7.10. It is interesting to note that the blank was just 24 photon counts (AU).



**Figure 7.9.** Peak for 2 mM aspartame solution obtained with manifold presented in Figure 7.7.



**Figure 7.10.** Trendline for aspartame concentrations 0.02-2 mM prepared using manifold presented in Figure 7.7.



After the aspartame stream confluent with  $\alpha$ -CHY stream the programme stops the pump for a fixed preincubation time for the methanol to build up. The effect of preincubation time is shown in Table 7.5. According to this data the peak signal was almost constant for preincubation time up to 120 s. Decrease is observed when the pump is stopped for 600 s.

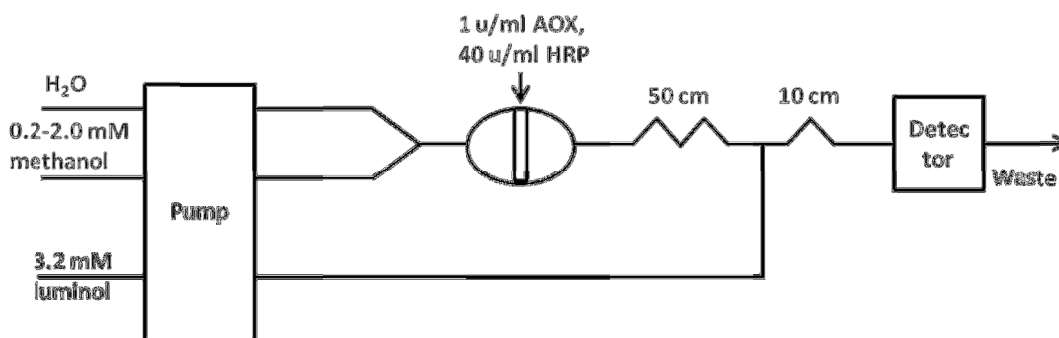
**Table 7.5.** *The effect of preincubation time on the peak heights.*

	<b>Photons count (AU)</b>	
	<b>C<sub>aspartame</sub> (mM)</b>	
<b>Preincubation time (s)</b>	<b>0.5</b>	<b>1</b>
<b>10</b>	4480	6520
<b>30</b>	4360	6632
<b>60</b>	4504	6520
<b>120</b>	4340	6472
<b>600</b>	3488	5664

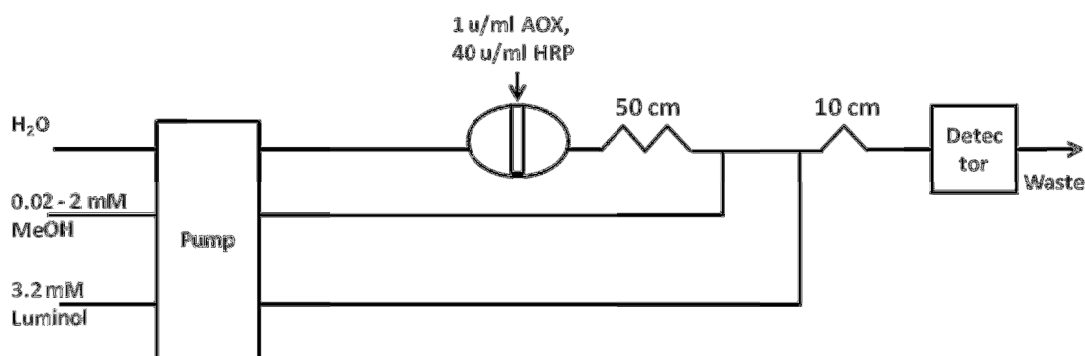
These preliminary manifolds proved that the fluidic system is functioning properly so it was decided to proceed with optimization.

## Optimization

The first step in the optimization was selecting the stream where the enzymes should be injected. Two possibilities are presented in Figures 7.11 and 7.12, namely injection into methanol solution and water. The possibilities were assessed through acquisition of calibration curves and checking peak shapes.

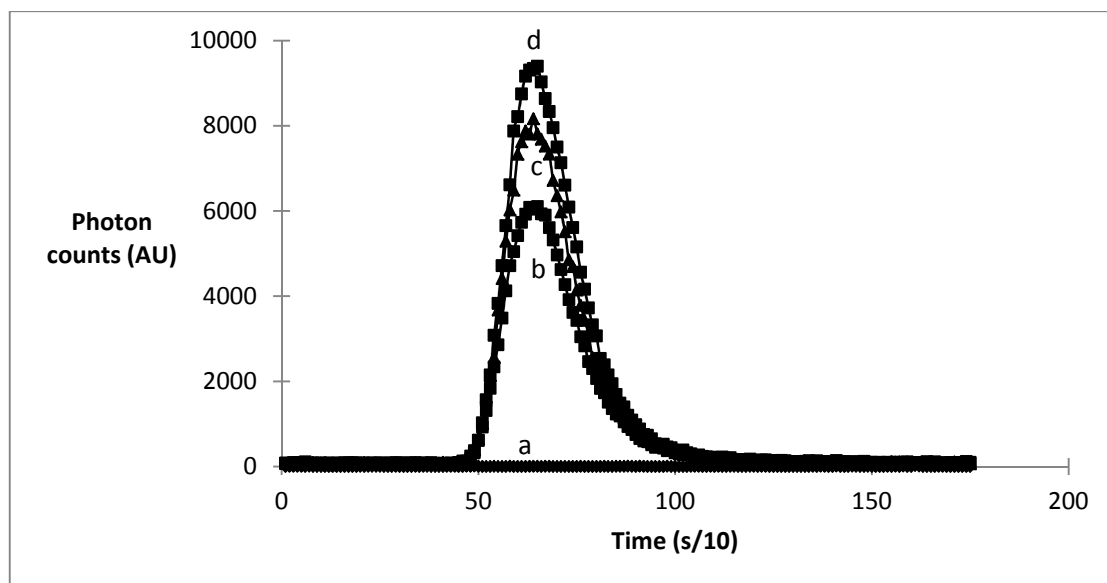


*Figure 7.11. Manifold of standard sensitivity.*

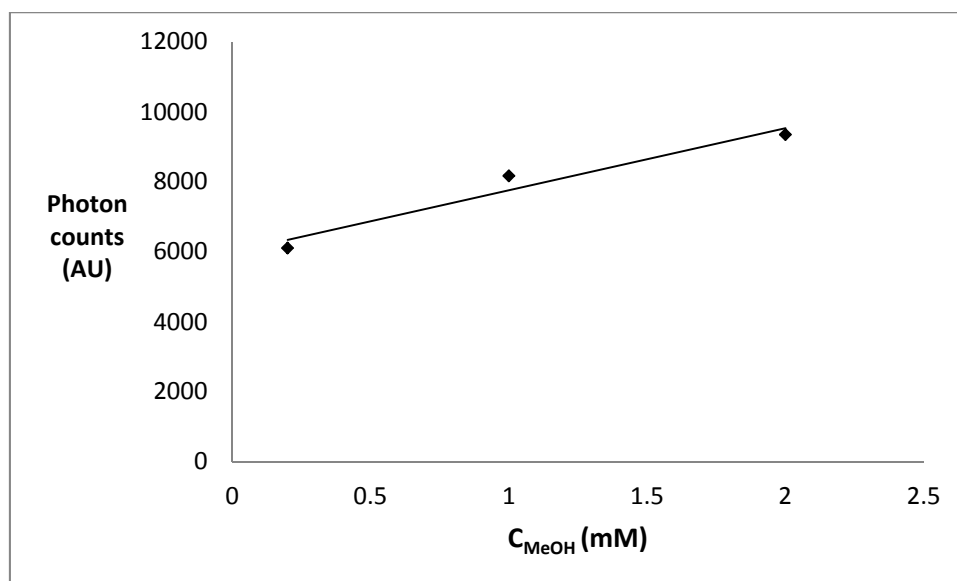


*Figure 7.12. Increased sensitivity manifold.*

Peaks obtained with manifolds shown in Figures 7.11 and 7.12 are presented in Figures 7.13 and 7.15 respectively. These peaks are higher than peaks shown in Figure 7.9 obtained using manifold shown in Figure 7.7. This means that sensitivity increases when using methanol rather than aspartame leading to the decision to perform the first analytical step, which is aspartame hydrolysis by  $\alpha$ -CHY, offline.



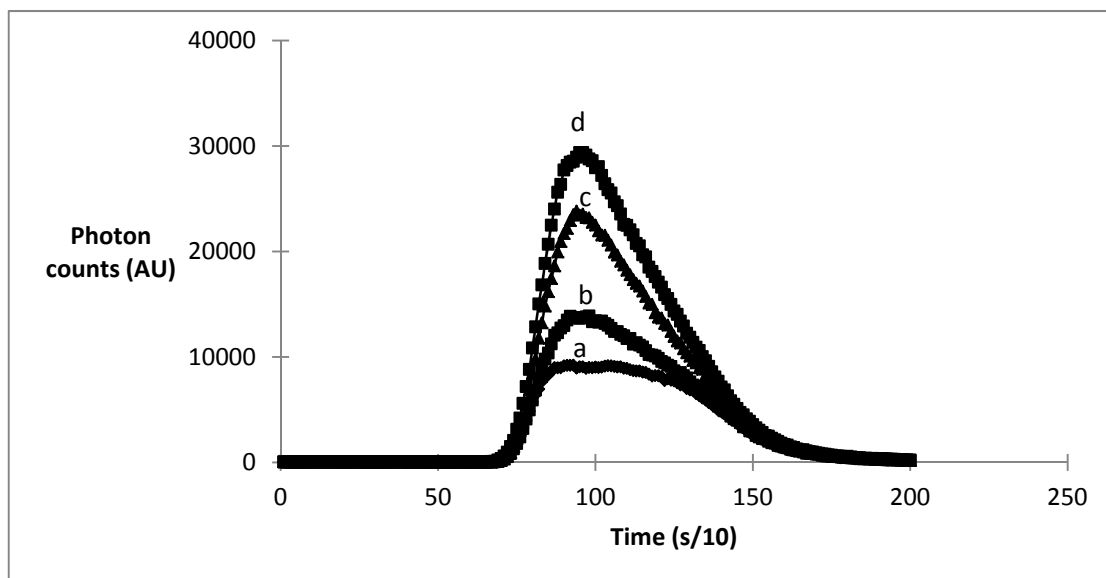
**Figure 7.13.** Chemiluminescent peaks obtained with manifold presented in Figure 7.11 for methanol concentrations 0-2 mM. Methanol concentrations: a) 0, b) 0.2, c) 1.0, and d) 2 mM.



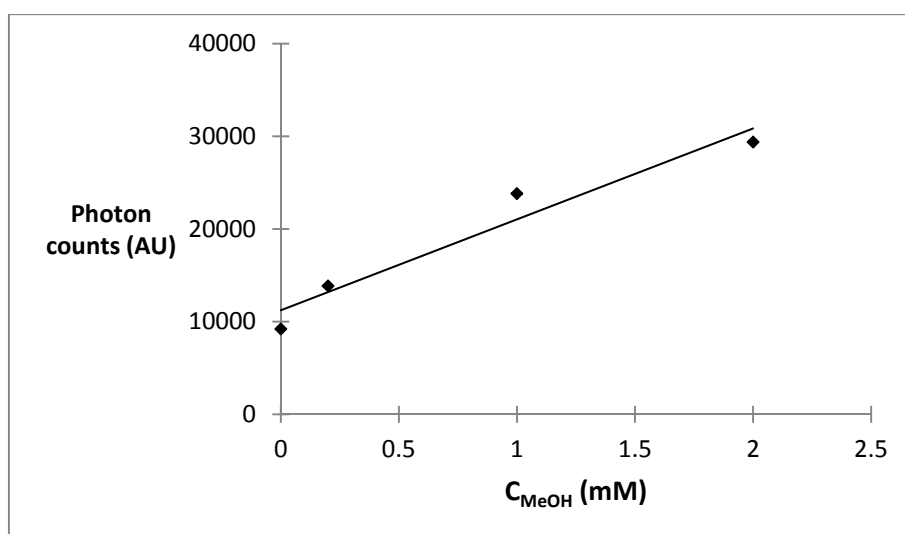
**Figure 7.14.** Calibration curve<sup>9</sup> for methanol concentrations 0.2-2 mM prepared using data from Figure 7.13. Calibration equation: photon counts (AU) = 3703 ( $\pm 1896$ )  $C$  (mM) + 2945 ( $\pm 2128$ ),  $r=0.8$ .

<sup>9</sup> Calibration data constructed out of three points are presented to show trends and were not used for sample concentrations calculations.

In the manifold presented in Figure 7.12 enzymes are injected into separate water line. This approach increases sensitivity, because when enzymes are injected into water sample dispersion is avoided. As a result peaks obtained with the manifold shown in Figure 7.15 are higher. Unfortunately this concerns also the peak of the blank.



**Figure 7.15.** Chemiluminescent peaks obtained with manifold presented in Figure 7.12 for methanol concentrations 0-2 mM. Methanol concentrations: a) 0 mM, b) 0.2 mM, c) 1 mM, d) 2 mM.



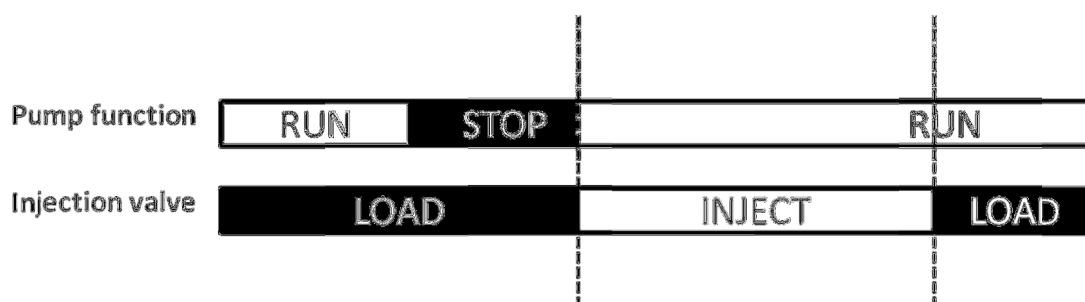
**Figure 7.16.** Calibration curve for methanol concentrations 0.2-2 mM prepared using manifold presented in Figure 7.12 and data from Figure 7.15. Calibration equation:

$Photon\ counts = 8497 (\pm 1954) \times C\ (mM) + 13297 (\pm 2532)$ ,  $r = 0.97$ . Blank value: 9216 photon counts (AU) was not included in the equation.

Within the optimization the effect of following parameters on the signal was investigated:

- ✓ Flow rate and peristaltic pump tube material,
- ✓ Mixing coils length, location and number,
- ✓ Preincubation time,
- ✓ AOX concentration,
- ✓ Use of separate solutions of AOX and HRP.

Timing sequence of the analyzer used during optimization is presented in Figure 7.17.

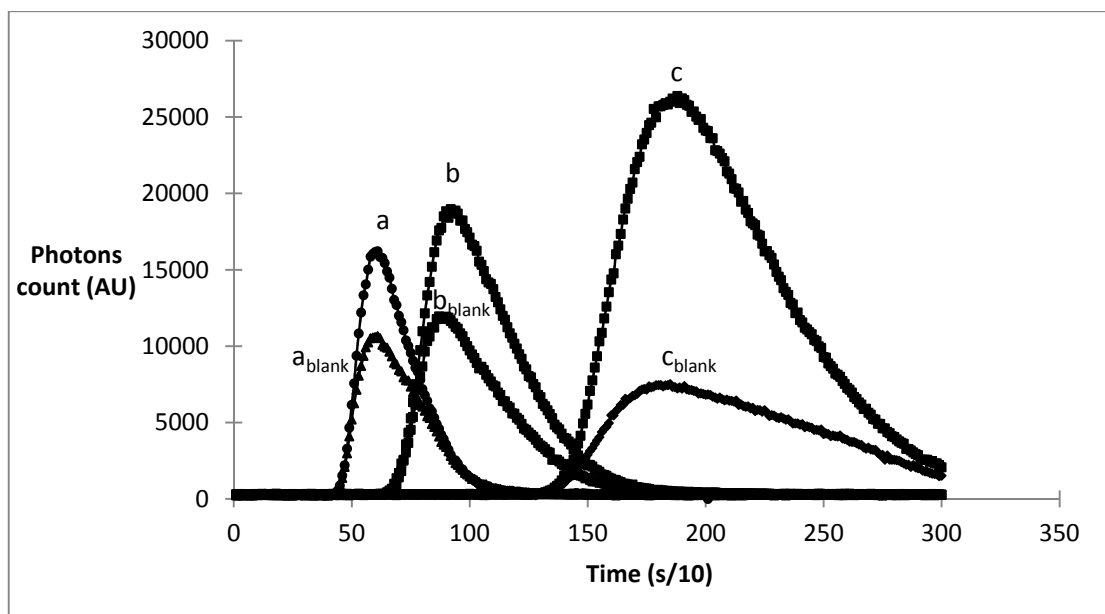


**Figure 7.17.** Timing sequence of the analyzer used throughout optimization.

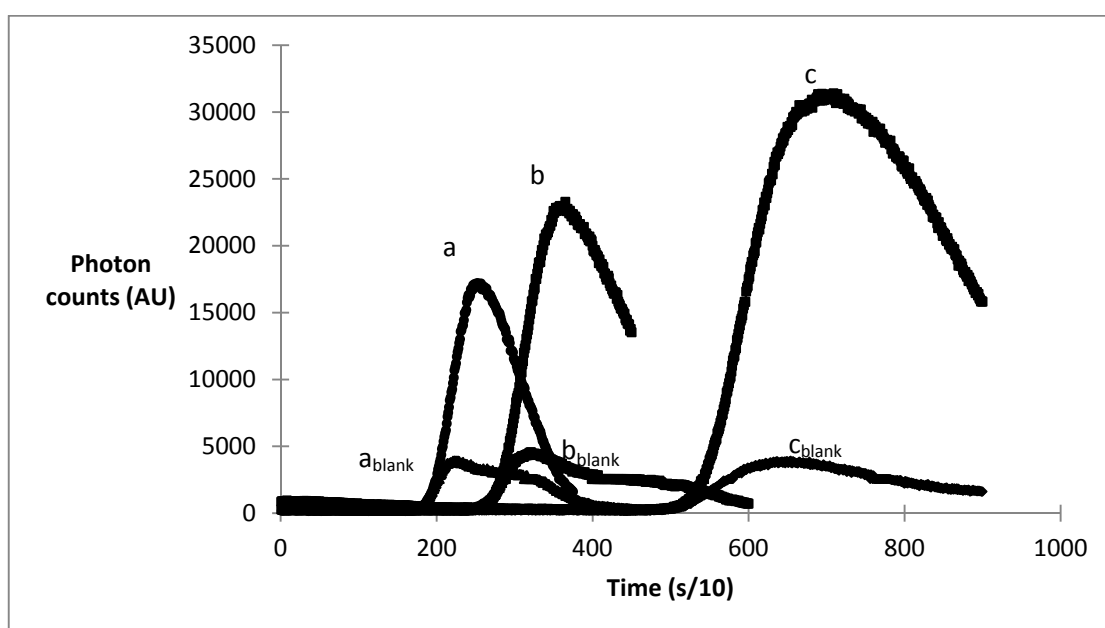
#### Flow rate and peristaltic pump tube material

Using the manifold presented in Figure 7.12 the effect of different flow rates was investigated. The test was performed using PTFE (I.D. 1.7 mm) and Tygon (I.D. 0.76 mm) tubing from Ismatec. Flow rates were varied from 0.65 to 7.7 ml/min/line. For each measurement corresponding blank measurement was performed where line with methanol was exchanged with reverse osmosis water.

The analytical signal and corresponding blanks is presented in Figure 7.18 for PTFE tubing and Figure 7.19 for Tygon tubing.



**Figure 7.18.** Flow rate effect on the analytical signal of 2 mM methanol standard using PTFE tubing (I.D. 1.7 mm). Flow rates: a) 7.7, b) 5.2 and c) 2.6 ml/min with corresponding blanks.



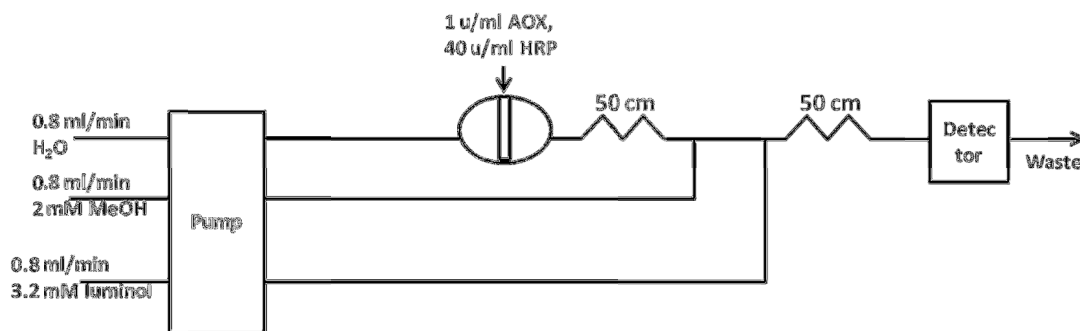
**Figure 7.19.** Flow rate effect on the analytical signal of 2 mM methanol standard using Tygon tubing (I.D. 0.76 mm). Flow rates: a) 2, b) 1.3 and c) 0.65 ml/min with corresponding

Two main conclusions from Figures 7.18 and 7.19 can be drawn. According to both graphs lower flow rate produces higher analytical signal. Additionally use of Tygon tubing results not only in higher signal in comparison to PTFE tubing but also produces lower and more stable (~5000 photon counts) blank irrespectively on the flow rate used. The possible advantage of Tygon tubing is its resistance towards methanol. As a result the carry over effect is minimized.

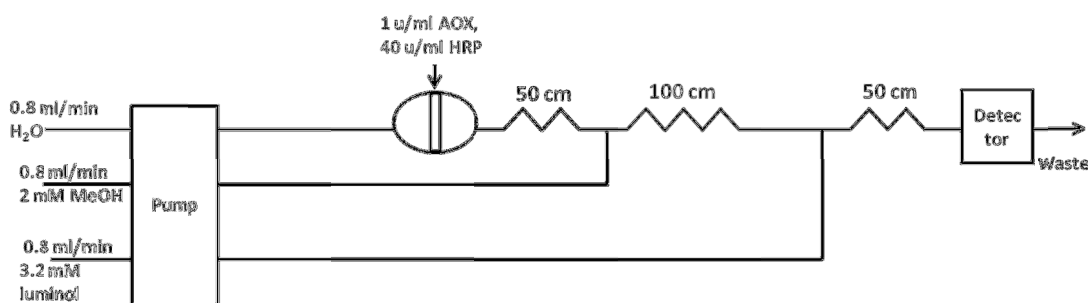
### Mixing coils

The effect of different combinations of mixing coils was studied using manifolds presented in Figures 7.20 – 7.22, this included:

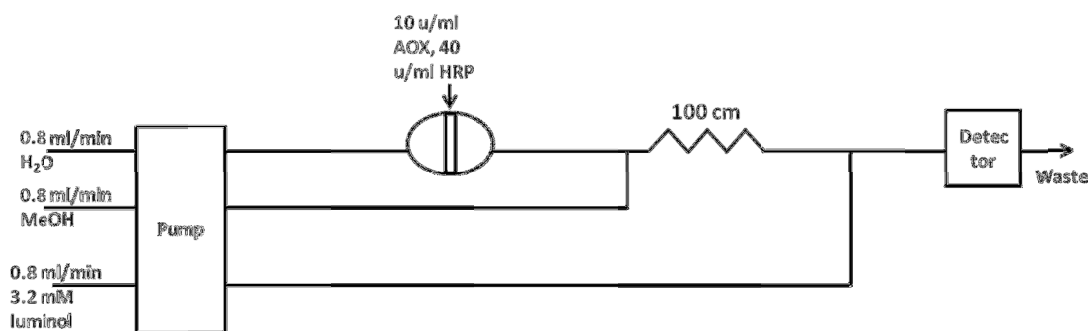
- extension of the second mixing coil to 50 cm, resulting in a manifold with two 50 cm mixing coils (Figure 7.20),
- addition of a 100 cm mixing coil after first T-junction, resulting in a manifold with two 50 cm mixing coils and one 100 cm mixing coil (Figure 7.21).
- deletion of the mixing coils after injection valve and after second T-junction, resulting in a manifold with one 100 cm mixing coil (Figure 7.22).



**Figure 7.20.** Manifold used for investigating the effect of extending second mixing coil.



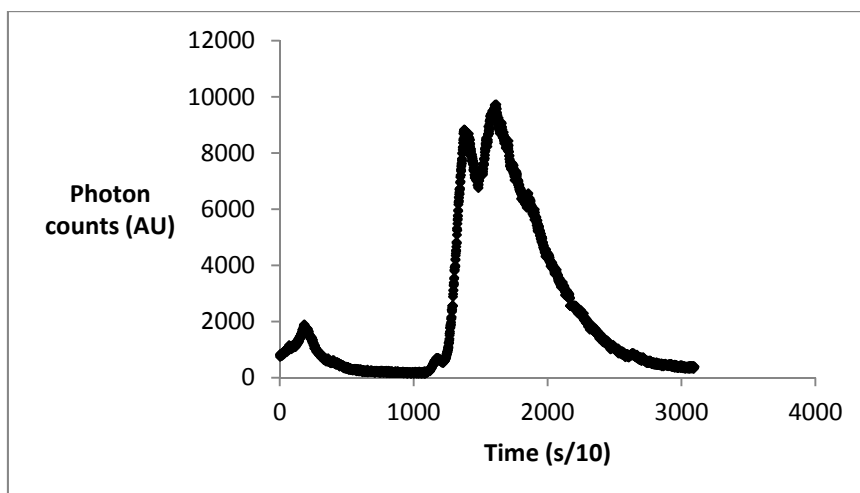
**Figure 7.21.** Manifold used for investigating the effect of three mixing coils.



**Figure 7.22.** Manifold used for investigating the effect of 1 mixing coil and increased AOX concentration (to 10 U/ml).

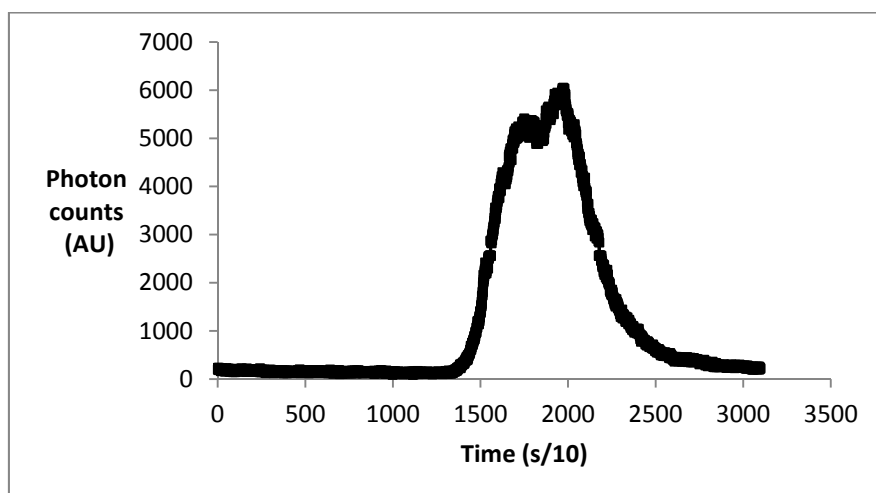
Results from manifold from Figures 7.20, 7.21 and 7.22 are presented in Figures 7.23, 7.24 and 7.25 respectively. Extension of the second mixing coil to 50 cm (Figure 7.20) resulted in a peak maximum of around 10000 photons count and double peak (Figure 7.23).





*Figure 7.23. Effect of extending second mixing coils to 50 cm on the analytical signal for 2 mM methanol standard. Manifold presented in Figure 7.20 was used.*

Although lower peaks (~ 6000 photon counts) were obtained with manifold from Figure 7.21 (Figure 7.24) their shape was closer to that expected in comparison to the previous manifold. Moreover repeated injections (not shown) resulted in almost identical peaks.

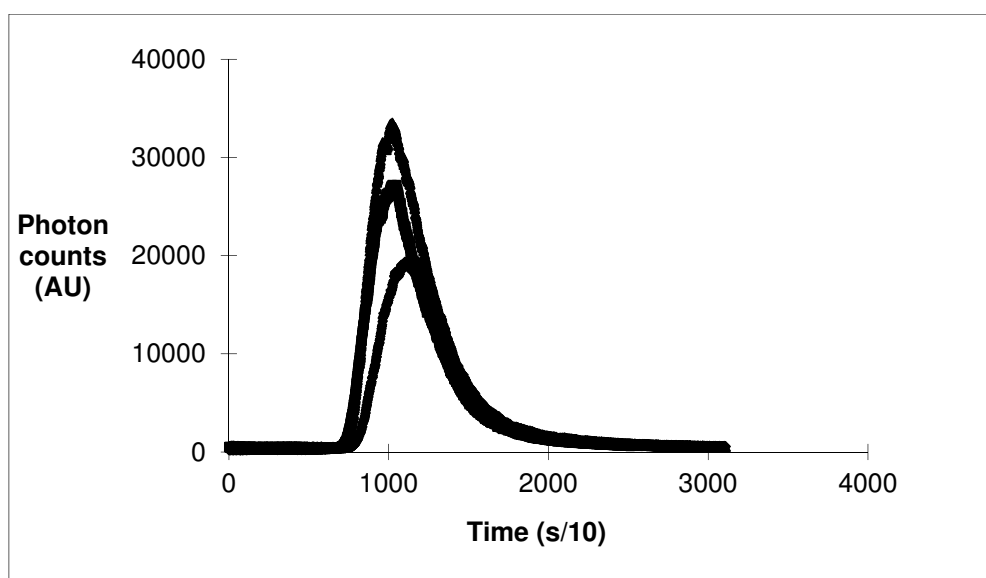


*Figure 7.24. Effect of extending insertion of the third mixing coil on the analytical signal for 2 mM methanol standard. Manifold presented in Figure 7.21 was used.*

The use of manifold from Figure 7.22 resulted in peaks shown in Figure 7.25. It should be noted that the third manifold was used with higher concentration of AOX:

10 U/ml. It was decided to use higher AOX concentration after visual observation of the signal increase.

The peaks obtained with manifold from Figure 7.22 are of well defined shape. The signal is higher than when using two previous manifolds, however 3 consecutive measurements were not of good repeatability.

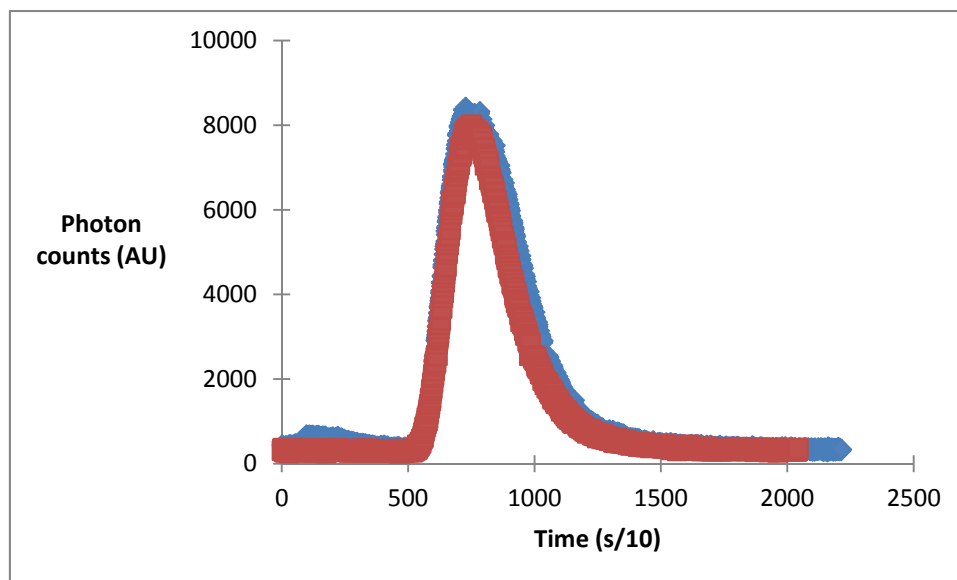


**Figure 7.25.** Effect of deletion of two mixing coils on the analytical signal for 2 mM methanol standard and of increasing AOX concentration to 10 U/ml. Manifold presented in Figure 7.22 was used, 3 consecutive measurements are presented.

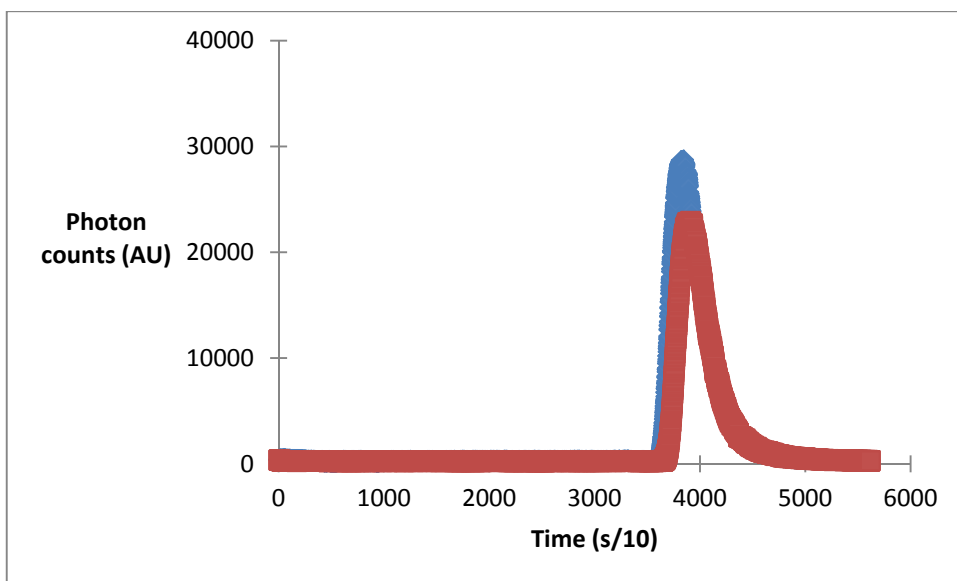
### Preincubation time

The next parameter to be investigated was preincubation time i.e. for how long the pump should be stopped when solutions have reached the centre of the mixing coil. The exact time at which pump should be stopped was measured by injecting PHP solution into the system and measuring the time after, which it arrives to the middle of the mixing coil. This time was equal to 60s. Preincubation time was controlled through the homemade LabVIEW program that stopped the peristaltic pump for a predetermined time. The effect of following preincubation times: 0, 1, 5 and 10 minutes is presented in Figures 7.26, 7.27, 7.28 and 7.29 respectively. Duplicated injections are shown. The choice of preincubation time was based on the analysis of repeatability, peak height and shape. The highest signal (~30000 photon counts), which at the same time was repeatable and produced well defined peak is presented in

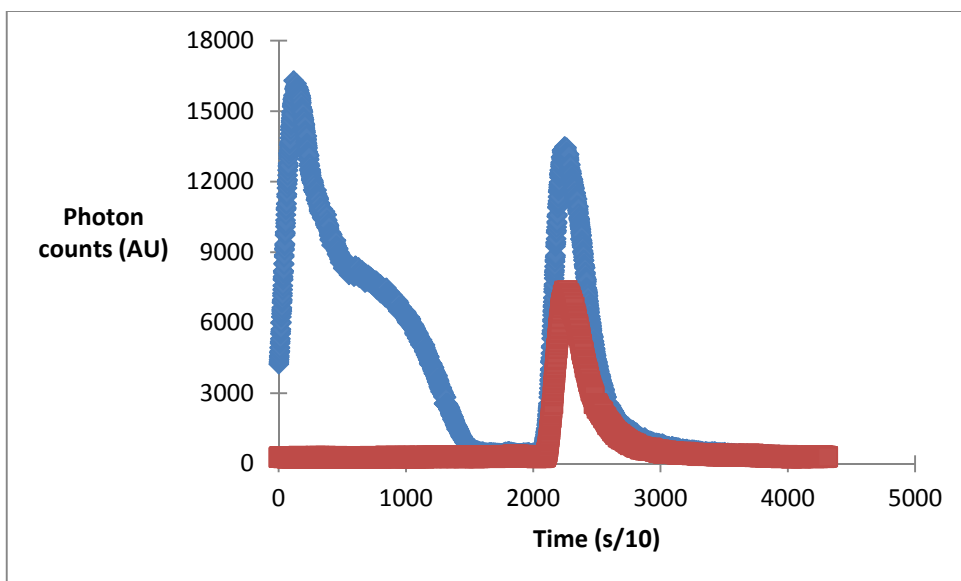
Figure 7.27 where preincubation time 1 minute is used. 5 minute preincubation (Figure 7.28) resulted in low repeatability and unexpected peak shapes. Although peak shapes are well defined for 10 min (Figure 7.29), to decrease analysis time 1 min was chosen.



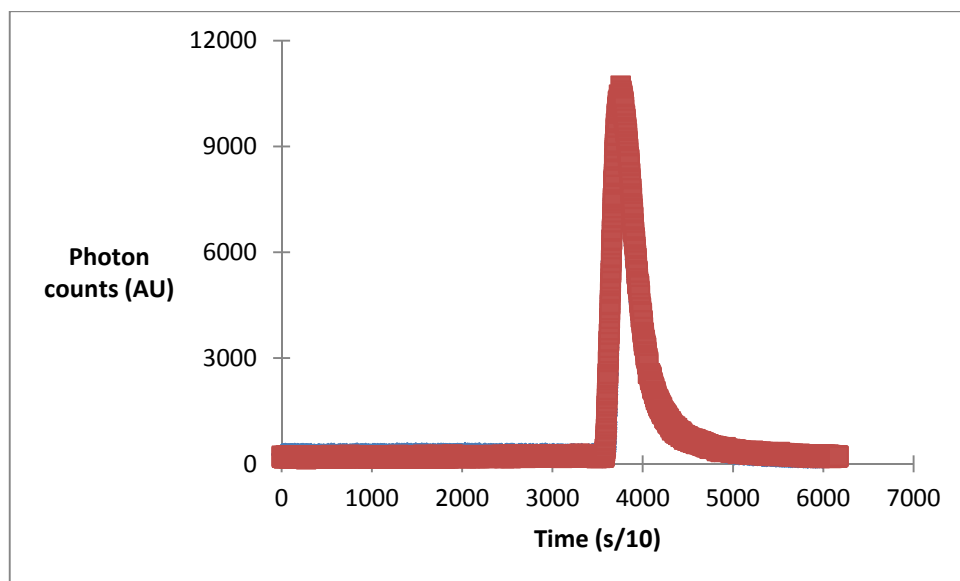
**Figure 7.26.** Analytical signal for methanol standard 2 mM when preincubation time is equal 0 min. Two measurements were performed, each measurement marked with different color.



**Figure 7.27** Analytical signal for methanol standard 2 mM with preincubation time equal 1 min. Two measurements were performed, each measurement marked with different color.



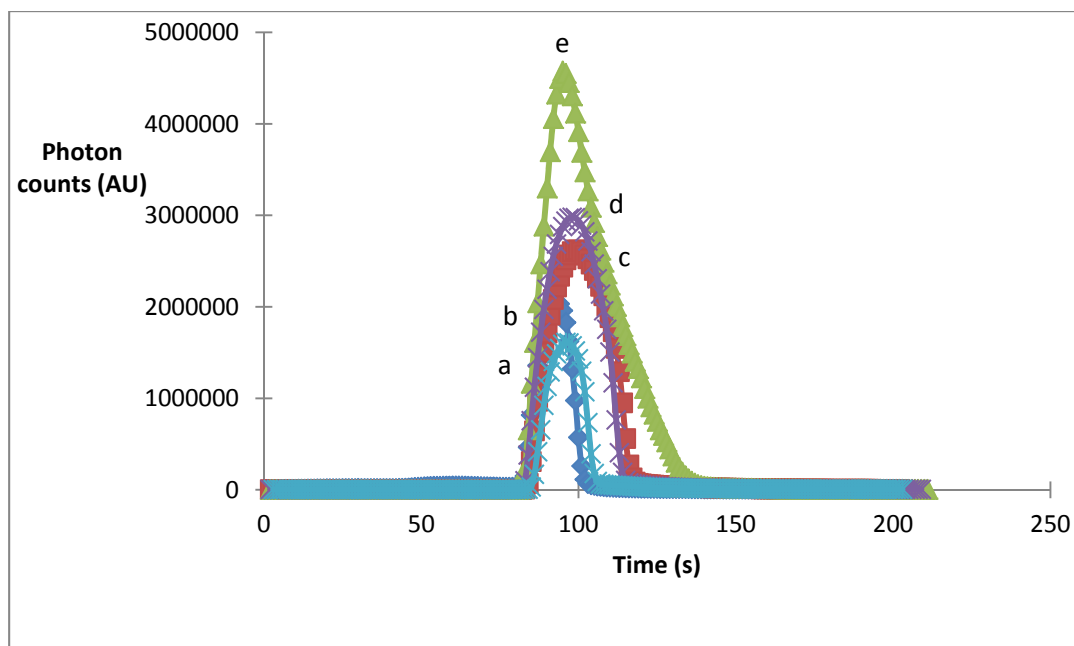
**Figure 7.28.** Analytical signal for methanol standard 2 mM with preincubation time equal 5 min. Two measurements were performed, each measurement marked with different color.



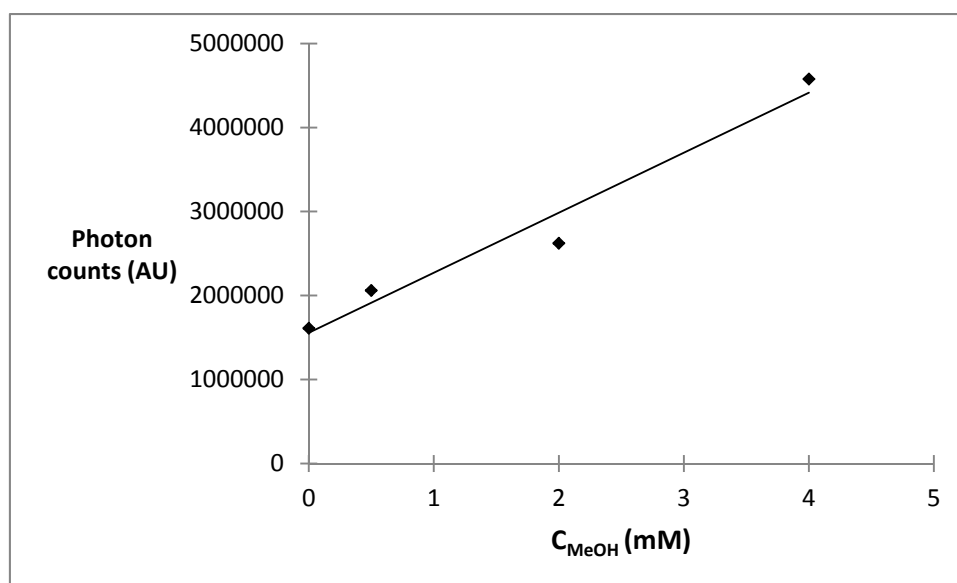
**Figure 7.29.** Analytical signal for methanol standard 2 mM with preincubation time 10 min. Two measurements were performed (not visible).

### ***Results and discussion***

Peak height for 8 mM is lower than that obtained for 4mM (Figure 7.30) due to the inner filter effect. That is why the calibration curve presented in Figure 7.31 was constructed for 0-4 mM.



**Figure 7.30.** Analytical signals for methanol standards 0-8 mM prepared using manifold presented in Figure 7.11. Methanol concentrations: a) 0, b) 0.5, c) 2, d) 8 and e) 4 mM.



**Figure 7.31.** Calibration curve constructed using manifold presented in Figure 7.3, using data from Figure 7.30. Calibration equation for concentrations 0-4 mM: photon counts (AU) = 714454 ( $\pm 97004$ ) C + 156801 ( $\pm 218259$ ).

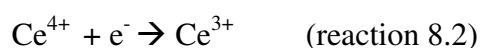
The study has shown that aspartame can be measured in the concentration range found in diet drinks and beverages using chemiluminescent detection. Further research like

optimization of luminol concentration and recovery study in diet drinks should be performed in the future.

## 8. Chemistries for potential automation of galacturonic acid determination

Kinetic studies, that can be used as a starting point for the development of a flow analyzer for galacturonic acid content in pectin, have been performed. Analyzer for galacturonic acid determination, together with the pectin methyl ester analyzer described in Chapter 6, would constitute a system for the determination of pectin degree of methylation. Within this thesis project new methods for galacturonic acid content based on common oxidizers i.e. iodine and cerium (IV) were tested. Initial steps to automate these methods were also performed.

Suggested hydrolysis method is based on enzymes employing appropriate mixture of pectinases, enzymes accountable for pectin degradation. After galacturonic acid is freely available, the oxidation with iodine or cerium (IV) is performed (reactions 8.1 and 8.2). The expected products of oxidation of galacturonic acid are mainly aldaric acids (Isbell and Holt, 1945). Their exact composition depends on the oxidizer. The stronger the oxidizer, the more bonds will be broken and more products will be formed. It is hard to predict the exact composition of oxidation products. It can be however determined experimentally by means of e.g. HPLC.



The reaction rate is followed by observing the decrease in color over time.

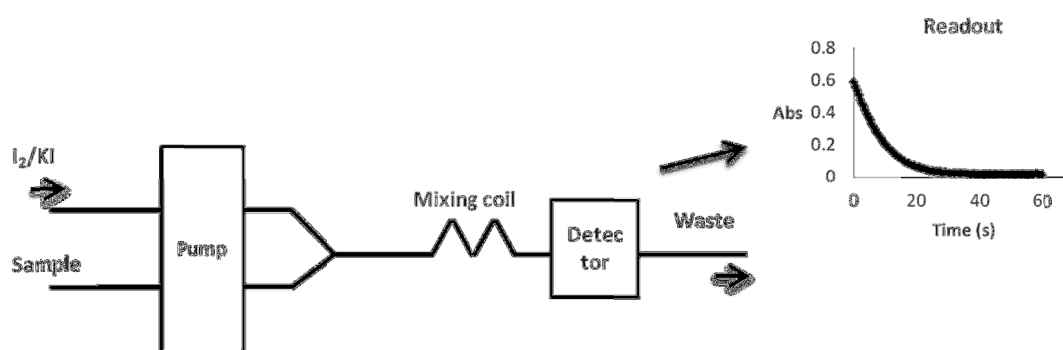
### 8.1. Galacturonic acid oxidation with iodine

#### *Materials and methods*

D-(+)-galacturonic acid was from Sigma Aldrich. All other reagents were analytical grade. 2.5 mM I<sub>2</sub> was prepared in 10 mM KI by dissolving appropriate amounts of KI and then I<sub>2</sub> in 50 ml. Then the solution was transferred to a 500 ml volumetric flask and filled to volume. 0.1, 0.3 and 0.5 % w/v D-(+)-galacturonic acid solutions, were prepared by dissolving appropriate amounts of galacturonic acid in deionized water and pH was adjusted to 4 with 1 M NaOH. 1 M Na<sub>2</sub>CO<sub>3</sub> was prepared by dissolving appropriate amounts of Na<sub>2</sub>CO<sub>3</sub> in deionized water.



Experimental procedure (manual): 1.5 ml galacturonic acid, 200  $\mu$ l 1 M  $\text{Na}_2\text{CO}_3$  and 1.5 ml 2.5 mM  $\text{I}_2$ / 10 mM KI were mixed in the cuvette of Jasco V-550 spectrophotometer and time course measurements was started immediately at 350 nm. Experiments were performed manually and then with the stopped-flow analyzer depicted in Figure 8.1 and using GILSON Minipuls 3 peristaltic pump. The analyzer consisted of two lines; first for 2.5 mM  $\text{I}_2$ /10 mM KI and second for mixed solution of galacturonic acid with 1M  $\text{Na}_2\text{CO}_3$ . Mixed solution of galacturonic acid with  $\text{Na}_2\text{CO}_3$  was prepared by mixing 10 ml galacturonic acid of each concentration with 2 ml 1M  $\text{Na}_2\text{CO}_3$ . The streams were merging in a T-junction, followed by a mixing coil and then reaching the flow cell in the spectrophotometer. On the arrival to the flow cell peristaltic pump was stopped and absorbance was monitored (Figure 8.1).



**Figure 8.1.** Schematic setup for the measurements for galacturonic acid oxidation with iodine.

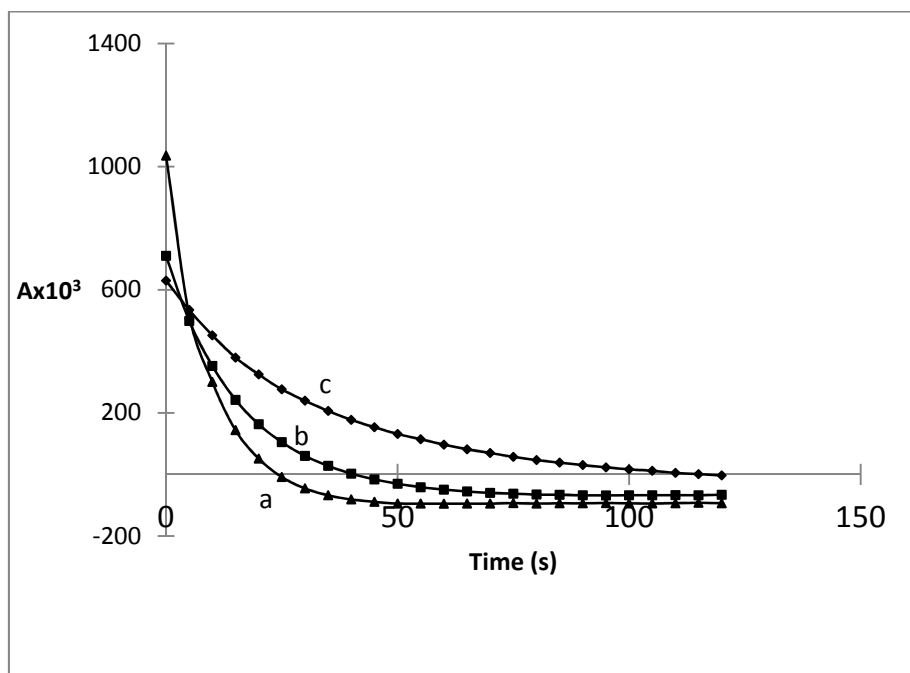
The idea to use iodine as an oxidizer for galacturonic acid being product of pectinase action is based on a enzymatic assay of pectinase available in the webpage of Sigma Aldrich (“Enzymatic Assay of Pectinase” ). The procedure used here does not employ the last step of the assay – titration, but focuses on the oxidation reaction.

## **Results and discussion**

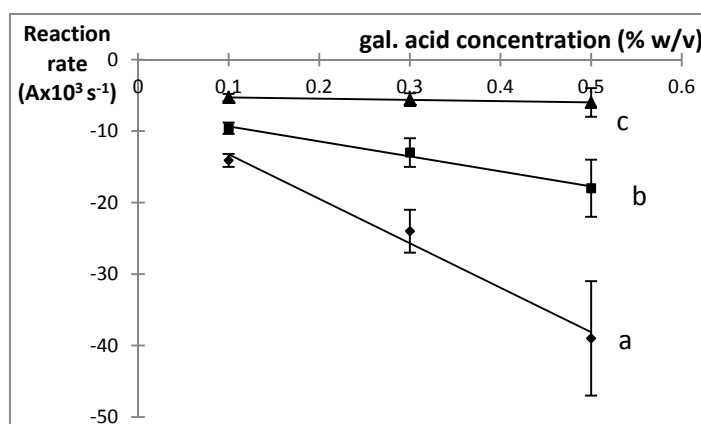
### Manual experiments

Time course measurements for 0.1, 0.3 and 0.5 % w/v galacturonic acid (Figure 8.2) were performed. Corresponding calibration curves for several analytical time ranges are presented in Figure 8.3. Results presented in Figure 8.3 show that longer analysis

time (0-100) flattens the calibration curve as data after completion of the reaction is included in the curve. The expected order of lines for the first seconds of the measurement in Figure 8.2 should not be a, b, c (from top to bottom) but rather c, b, a, that is following the concentration. That probably means that manual measurement is not precise at all, at least in the initial part. Therefore automation was expected to strongly improve the precision.



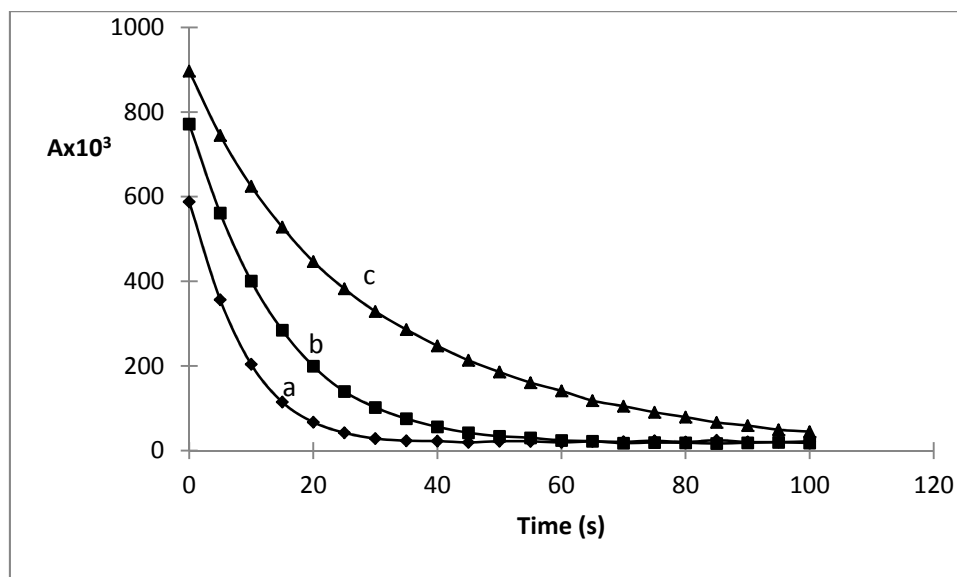
**Figure 8.2.** Time course measurements for following galacturonic acid concentrations a: 0.5, b: 0.3 and c: 0.1 % w/v.



**Figure 8.3.** Calibration curves<sup>10</sup> for measurements presented in Figure 8.2 prepared for different analytical time ranges. a: 0-25 s,  $\Delta A/\Delta t = -1.8 (\pm 0.1)$  C -5.11 ( $\pm 0.05$ ),  $r = 0.997$ , b: 0-50 s,  $\Delta A/\Delta t = -21 (\pm 2)$  C -7.2 ( $\pm 0.8$ ),  $r=0.994$ ; c: 0-100 s,  $\Delta A/\Delta t = -62 (\pm 7)$  C -7 ( $\pm 3$ ),  $r=0.993$ .

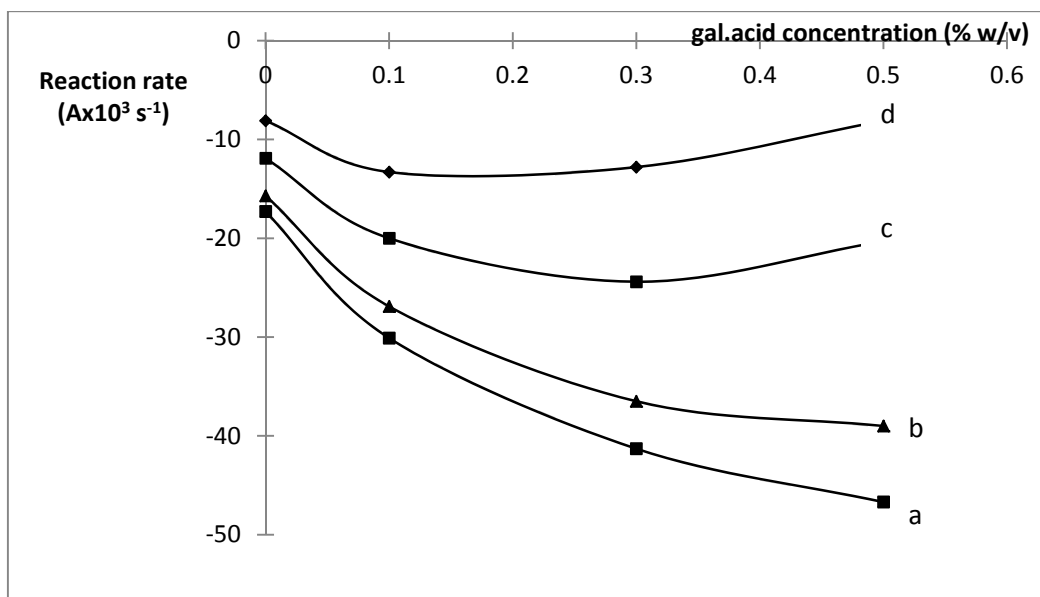
### Stopped-flow experiments

Stopped-flow time course measurements for 0.1 – 0.5 % w/v galacturonic acid are presented in Figure 8.4. Corresponding calibration curves prepared for different analytical time ranges are shown in Figure 8.5.



**Figure 8.4.** Time course measurements for different galacturonic acid concentrations a: 0.5, b: 0.3 and c: 0.1 % w/v performed using stopped-flow analyzer.

<sup>10</sup> Calibration data constructed out of three points are presented to show trends and were not used for sample concentrations calculations.



**Figure 8.5.** Calibration curves for measurements presented in Figure 8.4 for different analytical time ranges a: 0-5 s,  $\Delta A/\Delta t = -56 (\pm 12)$  C  $-21.2 (\pm 4)$ ,  $r = 0.96$ , b: 0-10 s,  $\Delta A/\Delta t = -45 (\pm 12)$  C  $-20 (\pm 4)$ ,  $r = 0.93$ ; c: 0-25 s,  $\Delta A/\Delta t = -15 (\pm 13)$  C  $-16 (\pm 4)$ ,  $r = 0.6$ ; d: 0-50 s,  $\Delta A/\Delta t = 2 (\pm 9)$  C  $-11 (\pm 3)$ ,  $r = 0.2$ .

From the data presented in Figure 8.5 it is concluded that when using the initial reaction rate a meaningful calibration data is observed. Initial reaction rates are possible to measure using only automated methods.

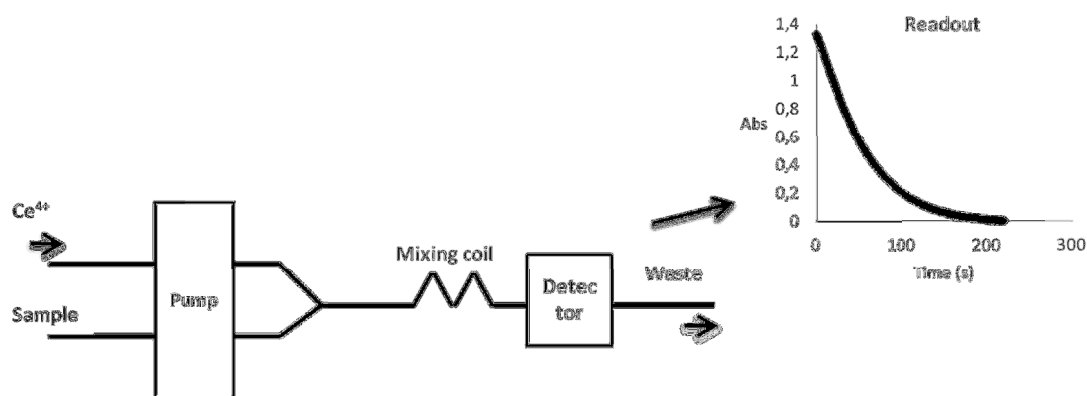
Since relatively high blank was observed during the measurements (results not shown) this issue should be further investigated before automation proceeds.

## 8.2. Galacturonic acid oxidation with cerium (IV)

### *Materials and methods*

Cerium ammonium sulphate dehydrate from Alfa Aesar, galacturonic acid and pectin from Sigma-Aldrich were used. 0.2 % cerium (IV) stock solution was prepared in 0.25 M sulphuric acid (Darwish et al., 2005) by dissolving appropriate amount of cerium ammonium sulphate dehydrate in 0.25 M sulphuric acid. 0.1, 0.3 and 0.5 % w/v D-(+)- galacturonic acid and 0.1, 0.3 and 0.5 % w/v pectin from citrus peel were prepared in deionised water by dissolving appropriate amounts in 100 ml deionized water.

Visual test was performed by mixing equal amounts of 0.1, 0.3 and 0.5 % w/v galacturonic acid and cerium stock solution and observing the change in color after 15 minutes. In the fourth test tube deionised water was mixed with cerium stock solution. The following dilutions of cerium stock solution were tested: 1:2, 1:10, 1:100 and 1:1000 in order to determine the suitable one. Cerium stock solution was diluted with deionised water. Manual experiments were performed using dilution 1:10, while in stopped-flow measurements the dilution 1:2 was used. Experiments were performed manually by mixing 1.5 ml cerium solution with 1.5 ml galacturonic acid and then with stopped flow analyzer with two lines; first for cerium solution and second for sample, being galacturonic acid or pectin. The stopped-flow analyzer depicted in Figure 8.6 and using GILSON Minipuls 3 peristaltic pump was used. Experiment with pectin was performed only by means of the stopped-flow analyzer. Both manual and stopped-flow measurements were performed with Jasco V-550 spectrophotometer at 350 nm. Spectrum of 0.021 % cerium solution is shown in Annex 1 (Figure A.1.3).



**Figure 8.6.** Stopped-flow analyzer for the measurements for galacturonic acid oxidation with cerium (IV).

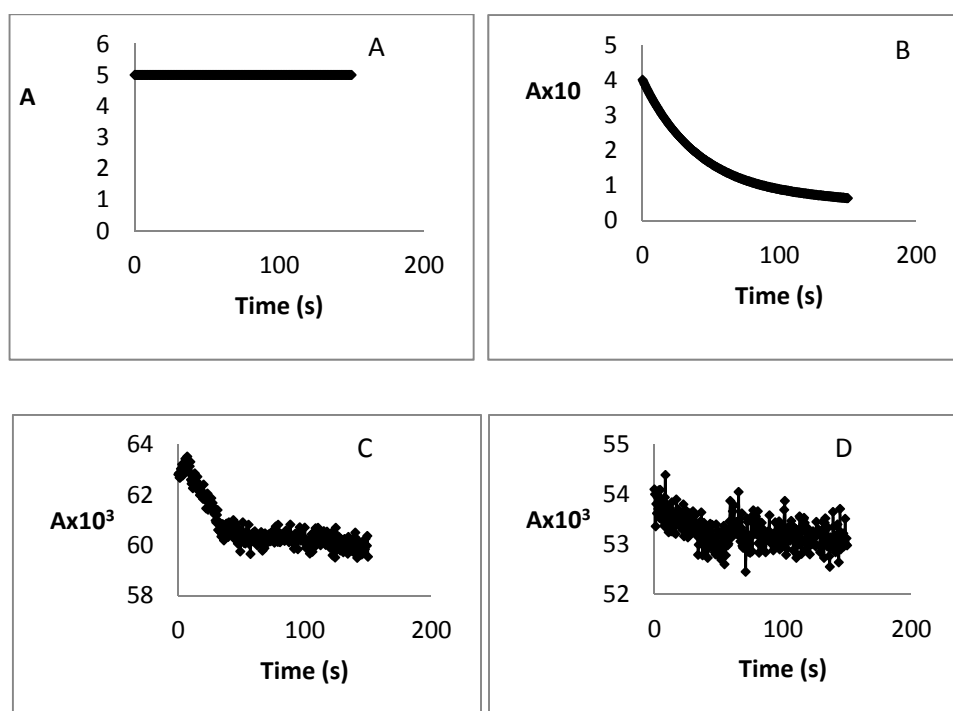
## **Results and discussion**

### Manual experiments

15 minutes after mixing different concentrations of galacturonic acid with cerium solution the color of the samples was compared visually. The reaction mixture containing the highest galacturonic acid concentration (0.5 % w/v) was the most transparent, while the solution containing lowest galacturonic acid concentration (0.1 % w/v) the most yellow. The starting color of all solutions was yellow - the color of

cerium solution. No color change was observed for the blank containing deionised water instead of galacturonic acid.

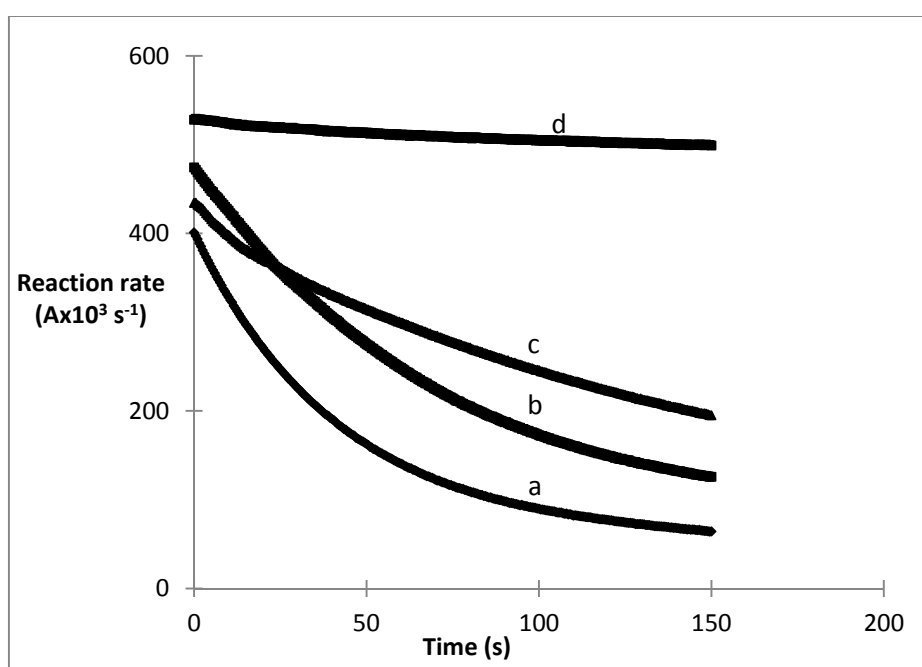
The effect of different cerium solution dilutions on the analytical signal when oxidizing 0.5 % w/v galacturonic acid are presented in Figure 8.7. When stock cerium solution was used absorbance values obtained were out of the monitoring range (Figure 8.7, A.). Dilution of the cerium stock solution in 1:10 ratio resulted in exponentially decreasing signal shown in Figure 8.7, B. Lower concentrations of cerium presented in Figures 8.7 C and D were resulting in not sufficient substrate oxidation. Out of this experiments stock dilution of 1:10 was selected for manual experiments.



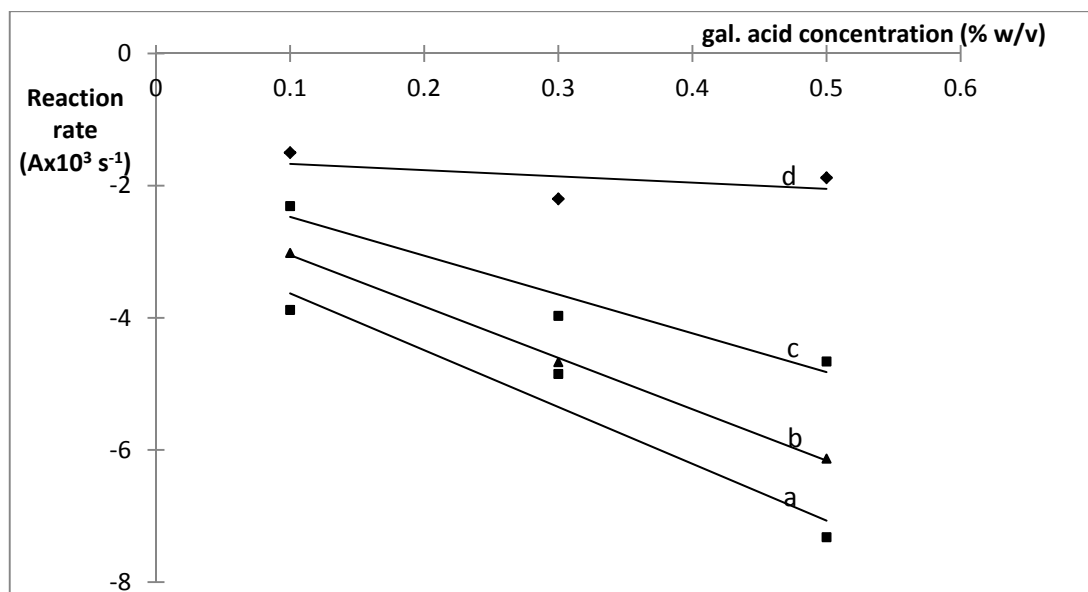
**Figure 8.7.** 0.5 % galacturonic acid oxidation with Ce (IV). Cerium solution of different concentrations was used: A. Stock cerium solution (0.2 % w/v), B. Stock cerium solution dilution 1:10, C. Stock cerium solution dilution 1:100, D. cerium solution dilution 1:1000.

Oxidation of 0.1-0.5 % galacturonic acid with 0.2 % w/v cerium solution, dilution 1:10 is presented in Figure 8.8. The steepness of the slope increases with increasing galacturonic acid concentration during the first seconds of the measurements. This is

confirmed when looking at Figure 8.9 where calibration curves for different analytical time ranges are presented. For analytical time range 0-150 s the (Figure 8.9; d) calibration curve increases for 0.5 % w/v galacturonic acid concentration losing therefore its meaningfulness for the analysis. Shorter analytical times present good linearity and should be considered (Figure 8.9; a, b and c). For final choice of analytical time range it would be however beneficial to take into account results obtained from automated experiments as this would eliminate any doubts that might be arising from very easy to introduce human error when measuring initial reaction rates.



**Figure 8.8.** Oxidation of different galacturonic acid concentrations: a) 0.5, b) 0.3, c) 0.1 and d) 0 % w/v galacturonic acid with 0.2 % w/v cerium solution, dilution 1:10.



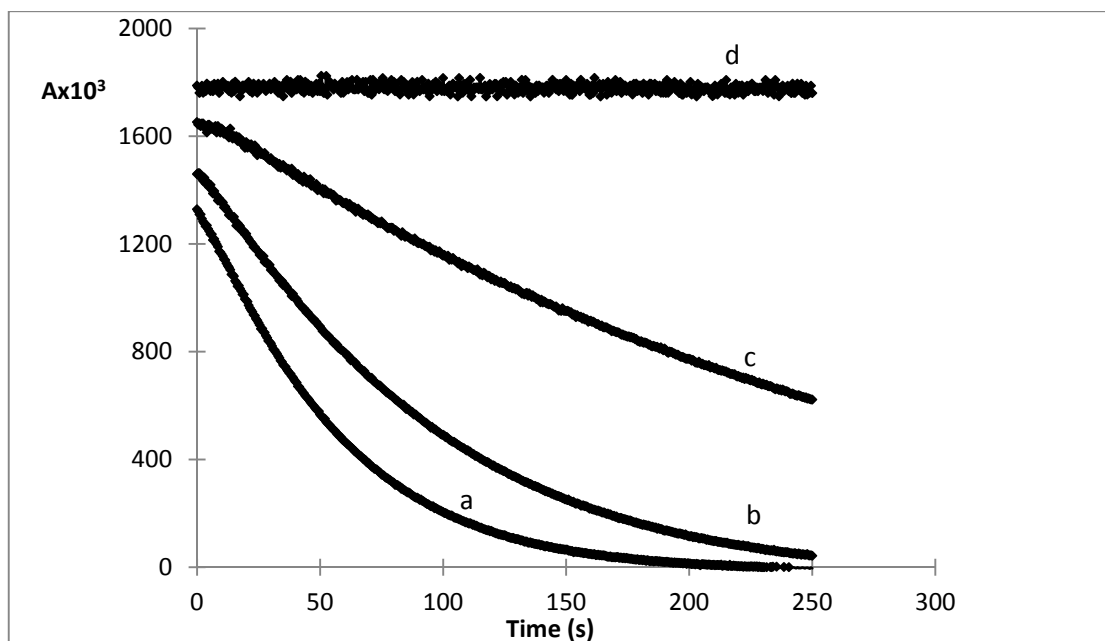
**Figure 8.9.** Calibration curves<sup>11</sup> for measurements presented in Figure 8.8 prepared for analytical time ranges: a) 0-10, b) 0-25, c) 0-50 and d) 0-150 s.

### Stopped-flow measurements

The results of stopped-flow measurements are presented in Figure 8.10. Corresponding calibration curves for analytical time ranges up to 200 s are shown in Figures 8.11 A. and B.

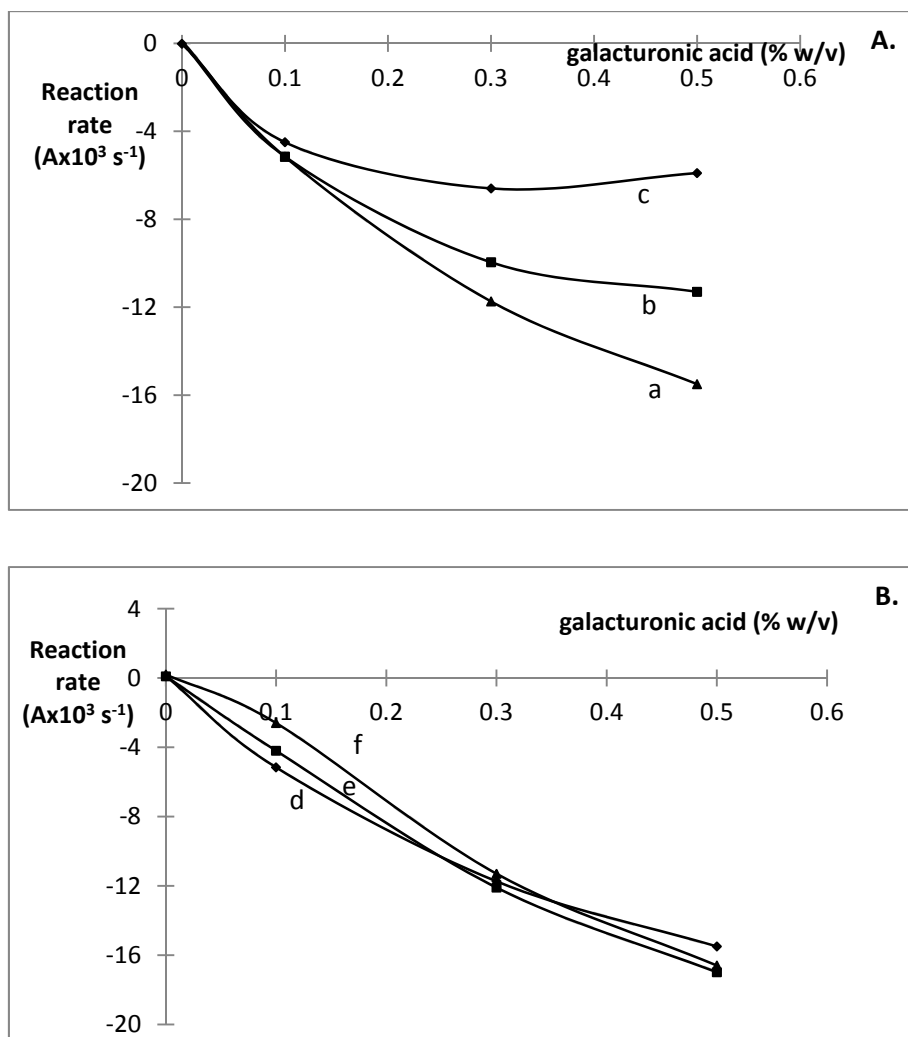
<sup>11</sup> Calibration data constructed out of three points are presented to show trends and were not used for sample concentrations calculations.





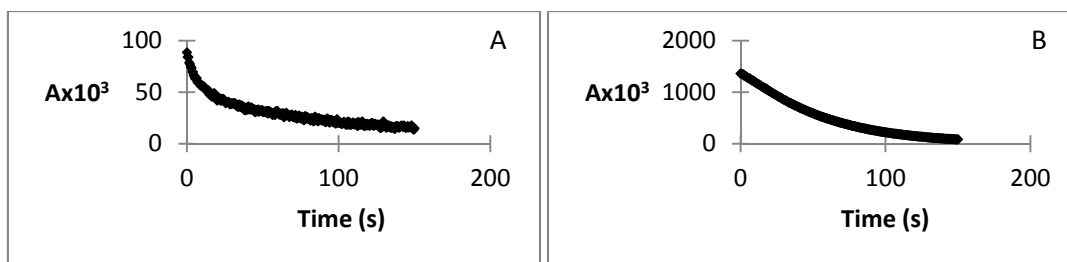
**Figure 8.10.** Time course measurements for galacturonic acid concentrations: a) 0.5, b) 0.3, c) 0.1 and d) 0 % w/v. Cerium stock solution dilution 1:2.

Figure 8.11, A which shows calibration curves for higher analytical time ranges proves that the calibration curve improves with decreasing analytical time from the first 200 s down to first 50 seconds. Further decrease of the analytical time ranges down to first 10 seconds of the measurement is shown in Figure 8.11 B. Analytical time ranges of 0-10 s (f), 0-25s (e) and 0-50 s (d) result in comparable calibration curves. This is confirmed by identical slopes obtained for each analytical time range;  $-35 \pm 3$ ,  $-34 \pm 3$  and  $-31 \pm 4$  respectively.



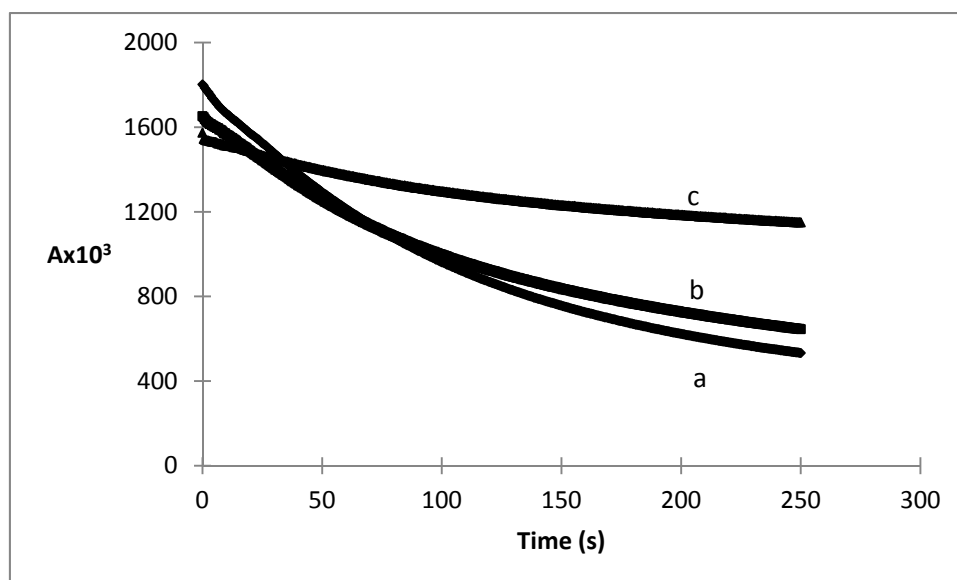
**Figure 8.11.** Calibration curves for measurements presented in figure 8.6 prepared for analytical time ranges: A. a) 0-50 s, b) 0-100 s, c) 0-200 s and B. d) 0-50 s, e) 0-25 s f) 0-10 s.

Cerium stock solution dilution was based on the results shown in Figure 8.12. Out of tested dilutions 1:2 was chosen as it resulted in around 10 times higher signal.

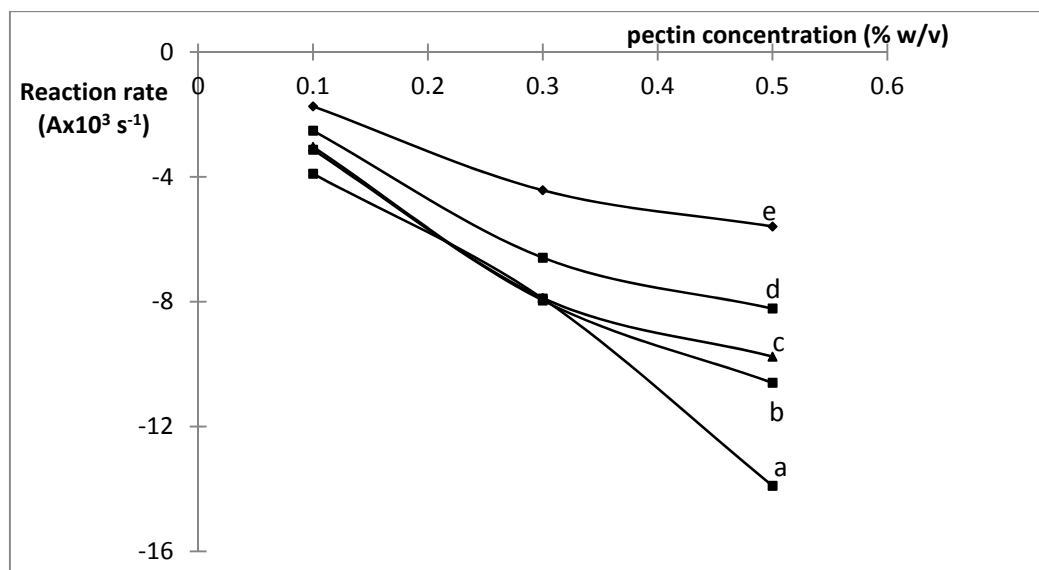


**Figure 8.12.** 0.5 % w/v galacturonic acid oxidation with 0.2 % cerium solution diluted 1:10 (A) & 1:2 (B).

The ability of cerium (IV) to oxidize pectin was investigated. As presented in Figure 8.13 cerium (IV) oxidizes pectin in concentrations 0.1-0.5 % w/v. Corresponding calibration curves for different analytical time ranges are presented in Figure 8.14.



**Figure 8.13** Time course measurements for different pectin concentrations: a) 0.5, b) 0.3 and c) 0.1 % w/v.



**Figure 8.14** Calibration curves<sup>12</sup> for measurements in Figure 8.13 prepared for different analytical time ranges: a) 0-10 s, b) 0-20, c) 0-50 d) 0-100 and e) 0-200 s.

To conclude the method of galacturonic acid quantification by its oxidation with cerium (IV) shows good automation prospects. Since it has been proven that pectin is also oxidized by cerium it is necessary to assure complete pectin hydrolysis prior to analyzing galacturonic acid with cerium (IV) as an oxidizer. Additionally, when constructing calibration curve it is necessary to choose right analytical time range. Additional benefit offered by the method is that no blank was observed. Blank was one of potential problems in method based on galacturonic acid oxidation by iodine. Further study should include interferences assessment, complete automation of the procedure as well as selection of appropriate pectinases for pectin hydrolysis.

<sup>12</sup> Calibration data constructed out of three points are presented to show trends and were not used for sample concentrations calculations.

## Conclusions and further research perspectives

In this thesis development of novel, green methods for methyl esters in foodstuffs is described. The study focuses on two methyl esters; one of them being natural ester: pectin methyl ester and the other aspartame - artificial sweetener, a methyl ester of aspartic acid/phenylalanine dipeptide. Development of the methods for their determination is presented in this thesis. Special attention is paid to the selection of chemistries behind the methods to be automated. The aim was to create new, accurate methods which are as environmentally friendly as possible; therefore the reactions based on enzymes are given priority.

The methods for pectin methyl esters and for aspartame determinations are based on the methyl ester structure of the target analytes. First, methyl ester is enzymatically hydrolysed by pectin methylesterase or  $\alpha$ -chymotrypsin and methanol is one of the products. That is the reason why in the course of development of the methods for pectin methyl esters and aspartame a search for the most suitable methanol determination method was performed. The following methanol determination methods have been tested, with special attention to their prospects as candidates for automation:

- ✓ through hydrogen peroxide measurement with ABTS,
- ✓ through hydrogen peroxide measurement with 4-AAP and phenol,
- ✓ through formaldehyde measurement.

Methanol determination by hydrogen peroxide measurement with ABTS was rejected due to significant blank signals. Methanol determination by formaldehyde measurement was showing potential for automation but the priority was given to the methanol determination by hydrogen peroxide measurement with 4-AAP/phenol. This method was optimized and its robustness was investigated. Also the ascorbic acid interference removal with 4-hydroxy TEMPO was tested. 4-AAP method was chosen as a suitable candidate for automation.

Development of two automated methods for methyl esters determination is described:

- ✓ Pectin methyl esters determination with spectrophotometric determination,

- ✓ Aspartame determination with chemiluminescent determination.

The method for pectin methyl esters is the first work on pectin analysis through flow injection. Detection limit down to 1.47 mM was achieved at the analysis rate of 7 samples h<sup>-1</sup>. It was proven that method provides identical results with manual off-line method.

The development of the aspartame determination method was preceded by the development of a spectrophotometric method for aspartame determination. The spectrophotometric method showed good results in samples containing higher aspartame concentrations than expected in beverages. It was concluded that enhancement of the detection sensitivity would lead to significant method improvement and possible application in beverages. To achieve that chemiluminescent detection was selected for the automated method. Further work focused on the development of chemiluminescent analyzer for aspartame detection. The chemistry from kinetic study was modified to accommodate luminol chemiluminescent detection and optimization of the system was performed to obtain the highest possible signal. Several manifolds were constructed and the effect of following parameters was tested:

- ✓ Flow rate,
- ✓ Mixing coils length, location and number,
- ✓ Preincubation time,
- ✓ Alcohol oxidase concentration,
- ✓ Use of separate solutions of AOX and HRP.

0.8 ml/min/line flow rate in combination with one 100 cm mixing coil, 60 s preincubation and use of separated solutions of AOX and HRP resulted in sufficient sensitivity that allowed for construction of a calibration curve within the range of aspartame concentration found in diet drinks.

Additionally, following side projects related to the main topic of the study are described: development of PME activity assay and galacturonic acid determination.

From the work described in this thesis following conclusions can be drawn:

- Flow methods are an interesting, green alternative to food analytical methods. Main environmental advantages are related to the minimal use of reagents and sample. However, in order to assure that the system is sustainable it is of special importance to pay attention to the chemistry used behind the method to be automated e.g. by replacing reagents with enzymes.
- Increase of analysis rate and decrease of detection limit would offer competitive techniques comparable to industrial methods. It would be beneficial to combine developed pectin methyl ester analyzer with a galacturonic acid analyzer. These two analyzers could be used for determining pectin degree of methylation. Additionally portability would definitely increase the attractiveness of the method. This would involve equipment miniaturization and possibly employ lab-on-a-chip technology.
- Thorough examination of the method before automation is a must. This not only shows the prospects of the method to be automated but also shows potential problems that can be encountered during automation e.g. too low detection limit. During development of aspartame determination method it was concluded that it would be beneficial to use more sensitive detection method i.e. chemiluminescence. This experience led to development of more sensitive automated method for aspartame determination.
- For some samples, choice of a suitable detection method is of special importance. In case of viscous samples, where carryover between the samples is expected more sensitive detection methods, i.e. chemiluminescence are advisable to allow higher sample dilution. The problem of carryover is then solved and additional washing step can be eliminated as well as the need for system saturation with additional injections prior to analysis. Method with more sensitive detection technique benefits from increased analysis rate and lower detection limit.
- At this point it was not possible to fully eliminate the use of chemical reagents and replace them with more environmentally friendly ones. However wherever possible enzymes instead of chemicals were used.

Work presented in this thesis has opened path for possible further development of following fluidic methods:

- ✓ chemiluminescent automated determination of pectin methyl esters,
- ✓ automated pectin methylesterase activity assay,
- ✓ automated pectin methyl esters determination through formaldehyde measurement,
- ✓ automated method for galacturonic acid determination.

Further studies should focus on enhanced enzyme use but also systems miniaturization and portability.



## Abbreviations

4-APP – 4-aminoantipyrine

A – Absorbance

ABTS – 2,2'-azinobis(3-ethylbenzthiazoline-6-sulfonic acid)

AOX – Alcohol oxidase

AU – Arbitrary units

C – Sample concentration after injection/dispersion

C<sup>0</sup> – Sample concentration before injection/dispersion

D – Dispersion coefficient

DNA – Deoxyribonucleic acid

DM – Degree of methylation

DRIFTS – Difuse reflectance infrared Fourier transform spectroscopy

EWS – Enzyme working solution

FDH – Formaldehyde dehydrogenase

FI – Flow injection

FT-IR – Fourier transform infrared

Gal. acid – Galacturonic acid

GC – Gas chromatography

HG – homogalacturonan (HG)

HM – High-metoxyl

HPLC –High performance liquid chromatography

HRP – Horseradish peroxidase

I – light transmitted through the sample

$I_0$  – light passing through the blank

I.D. – Internal diameter

IR – Infrared

LM –Low-methoxyl

LOD – Detection limit

NAD – Nicotinamide adenine dinucleotide

ND – Not detected

O.D. – Optical density

PHP – Phenolphthalein

PME –Pectin methylesterase

PTFE – Polytetrafluoroethylene

rFI – Reverse flow injection

$R^2$  – correlation coefficient

RG-I – rhamnogalacturonan-I

RG-II – rhamnogalacturonan II

RO – Reverse osmosis

RSD – Relative standard deviation

SE – Standard error

T – Transmittance

U - Unit

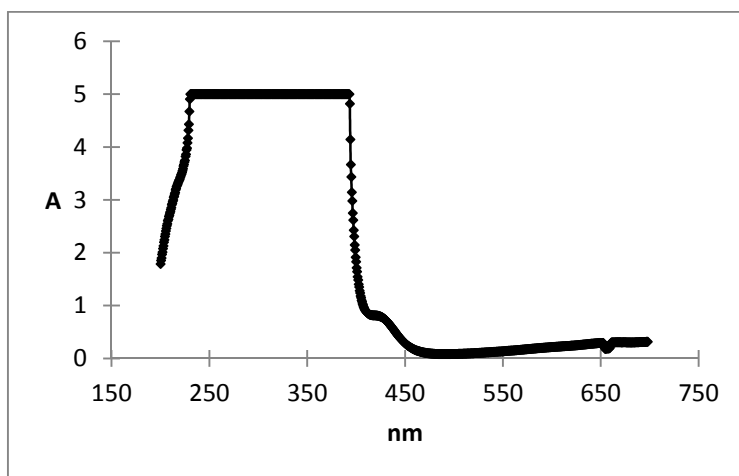
UV– Ultra violet

Vis -Visible

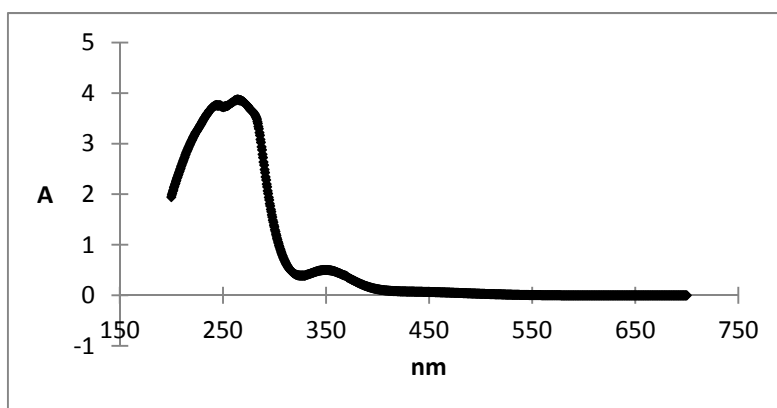
w/o – Without

$\alpha$ -CHY – alpha chymotrypsin

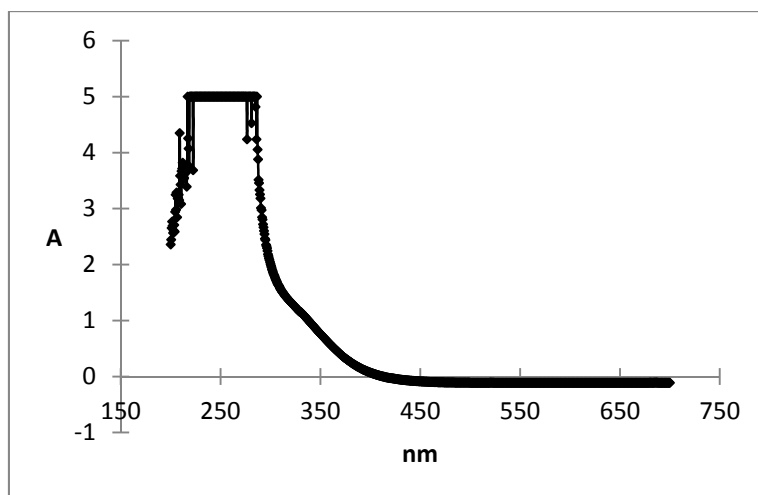
## Annex 1: Spectra



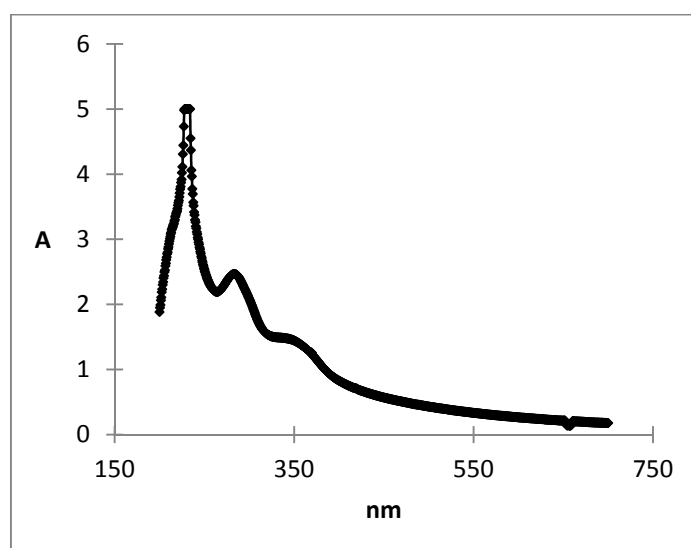
*Figure A1.1. Spectrum of 2,2'-azinobis(3-ethylbenzthiazoline-6-sulfonic acid) (ABTS),  $C_{ABTS} = 9.7 \text{ mM}$ .*



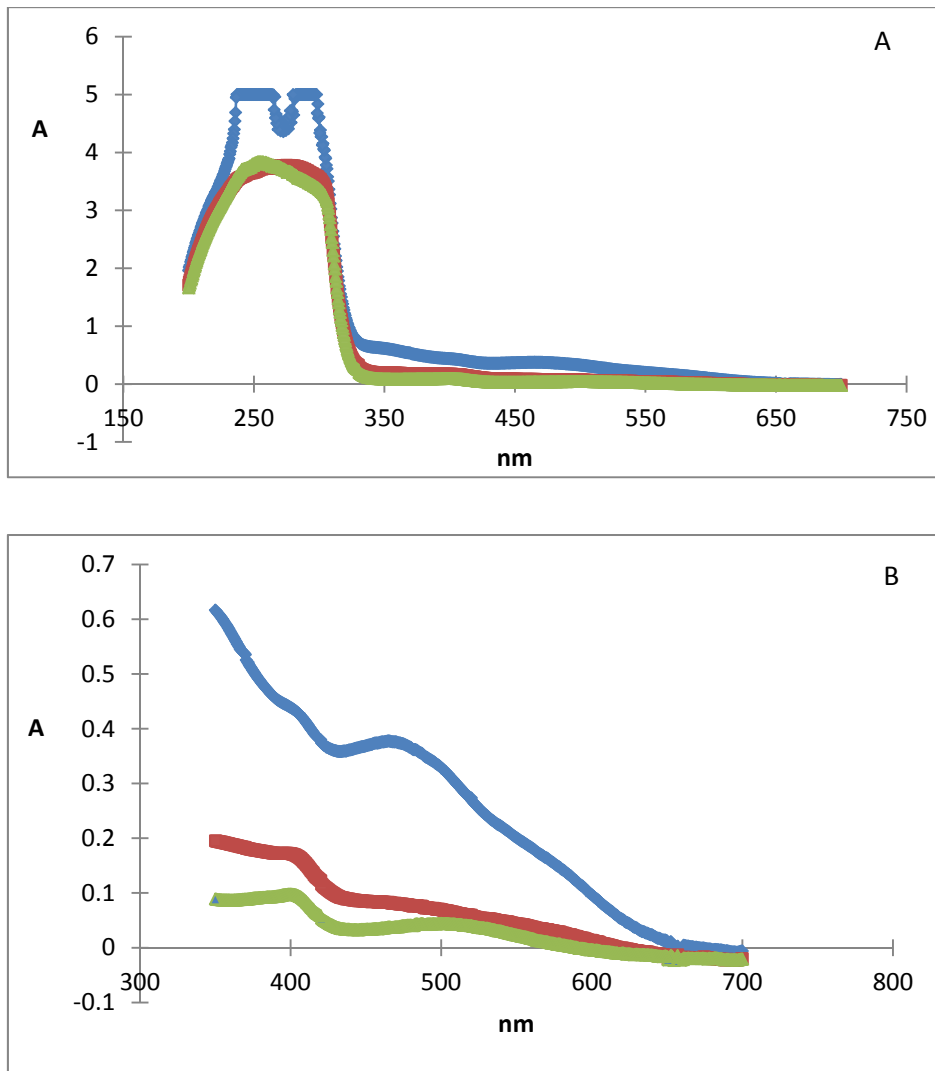
*Figure A1.2. Spectrum of I<sub>2</sub>/KI solution of concentration 0.3/1.3 mM.*



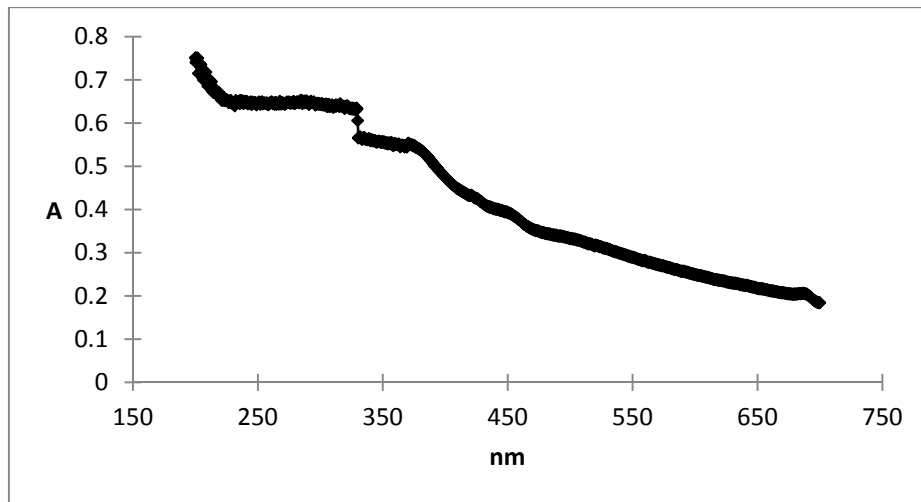
*Figure A1.3. Spectrum of 0.021 % w/v cerium ammonium sulphate dehydrate in 0.25 M sulphuric acid.*



*Figure A1.4. Spectrum of 0.5 % w/v pectin from citrus peel (Sigma Aldrich).*



**Figure A1.5.** A. Fresh enzyme working solution (EWS) (green), 1 month (red) and 5 months old (blue). B. Zoom on the spectrum part of interest for the experimental work (350-700 nm). EWS was stored in the fridge in between measurements.



*Figure A1.6 Spectrum of a freshly squeezed and filtered orange juice.*

## Annex 2: GILSON Minipuls 3 calibration data

Calculations are based on the measurements of the time required to fill X ml volumetric flask. X was selected in such a way that the filling procedure lasts from 5 to 15 min at 100 % potentiometer reading.

*Table A2.1 Calibration data for Elkay tubing for potentiometer set to 100 %.*

<b>Tubing type</b>	<b>I.D. (mm)</b>	<b>Flow rate (ml/min)</b>
<b>Elkay 116-0532-020</b>	0.19	0.24
<b>Elkay 116-0532-030</b>	0.25	0.45
<b>Elkay 116-0532-050</b>	0.51	1.39
<b>Elkay 116-0532-060</b>	0.64	1.98
<b>Elkay 116-0532-070</b>	0.76	2.56
<b>Elkay 116-0532-090</b>	1.02	4.27
<b>Elkay 116-0532-100</b>	1.14	5.6
<b>Elkay 116-0532-110</b>	1.3	6.7

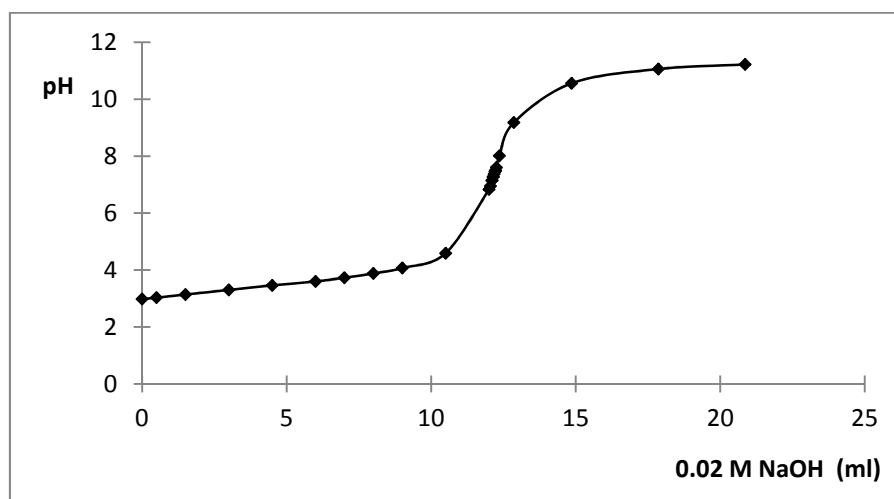
*Table A2.2 Calibration data for Ismatec tubing for potentiometer set to 100 %.*

<b>Tubing type</b>	<b>I.D. (mm)</b>	<b>Flow rate (ml/min)</b>
<b>SC0007 ENE-07</b>	0.64	1.99
<b>SC0009 ENE-09</b>	0.89	3.66
<b>SC00011 ENE-11</b>	1.02	4.6
<b>SC00013 ENE-13</b>	1.14	5.58
<b>SC00015 ENE-15</b>	1.3	7.3
<b>SC00017 ENE-17</b>	1.52	9.79
<b>SC00022 ENE-22</b>	2.29	17.91

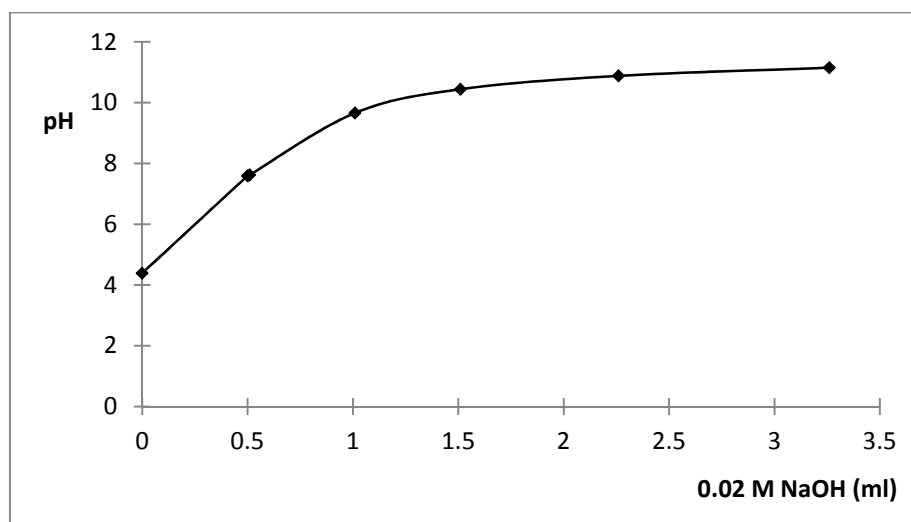


### Annex 3: Determination of PME activity in Pectinex 3 XL

Pectinex 3 XL is a pectolytic enzyme preparation from Sigma Aldrich. Pectinex 3 XL contains pectintranseliminase, polygalacturonase, and pectinesterase and small amounts of hemicellulases and cellulases from *Aspergillus Niger*. PME activity was measured according to the procedure described by (Maldonado et al., 1994).



**Figure A3.1.** Potentiometric titration with 0.02 M NaOH of pectin after 60 min incubation with Pectinex 3 XL at 35°C.



**Figure A3.2.** Potentiometric titration with 0.02 M NaOH of 0.1 M NaCl (blank) after 60 min incubation with Pectinex 3 XL at 35°C.

## Bibliography

- Aehle, W., 2007. *Enzymes in Industry: Production and Applications*. John Wiley & Sons.
- Almuzara, C., Cos, O., Baeza, M., Gabriel, D., Valero, F., 2002. Methanol determination in *Pichia pastoris* cultures by flow injection analysis. *Biotechnol. Lett.* 24, 413–417.
- Anthon, G.E., Barrett, D.M., 2004. Comparison of three colorimetric reagents in the determination of methanol with alcohol oxidase. Application to the assay of pectin methylesterase. *J. Agric. Food Chem.* 52, 3749–3753.
- Armenta, S., Garrigues, S., De La Guardia, M.D., 2004. FTIR determination of aspartame and acesulfame-K in tabletop sweeteners. *J. Agric. Food Chem.* 52, 7798–7803.
- Bartolome, L.G., Hoff, J.E., 1972. Gas Chromatographic methods for the assay of pectin methylesterase, free methanol, and methoxy groups in plant tissues. *J. Agric. Food Chem.* 20, 262–266.
- Batsoulis, A.N., Nacos, M.K., Pappas, C.S., Tarantilis, P.A., Mavromoustakos, T., Polissiou, M.G., 2004. Determination of Uronic Acids in Isolated Hemicelluloses from Kenaf Using Diffuse Reflectance Infrared Fourier Transform Spectroscopy (DRIFTS) and the Curve-Fitting Deconvolution Method. *Appl. Spectrosc.* 58, 199–202.
- Batterman, S.A., Franzblau, A., 1997. Time-resolved cutaneous absorption and permeation rates of methanol in human volunteers. *Int. Arch. Occup. Environ. Health* 70, 341–351.
- BeMiller, J.N., 2007. , in: *Carbonate Chemistry for Food Scientists*. AACC International, Inc., St. Paul, pp. 303–311.
- Benoit, I., Coutinho, P.M., Schols, H.A., Gerlach, J.P., Henrissat, B., Vries, R.P. de, 2012. Degradation of different pectins by fungi: correlations and contrasts between the pectinolytic enzyme sets identified in genomes and the growth on pectins of different origin. *BMC Genomics* 13, 321.
- Bergamin F, H., Zagatto, E.A.G., Krug, F.J., Reis, B.F., 1978. Merging zones in flow injection analysis□: Part 1. Double proportional injector and reagent consumption. *Anal. Chim. Acta* 101, 17–23.
- Blumenkrantz, N., Asboe-Hansen, G., 1973. New method for quantitative determination of uronic acids. *Anal. Biochem.* 54, 484–489.
- Burfeind, J., Weigel, B., Kretzmer, G., Schügerl, K., Huwig, A., Giffhorn, F., 1996. Determination of the concentration of higher alcohols with enzyme coupled flow-injection analysis in model systems. *Anal. Chim. Acta* 322, 131–139.

- CFR - Code of Federal Regulations Title 21 [WWW Document], 1974. URL <http://www.accessdata.fda.gov/scripts/cdrh/cfdocs/cfCFR/CFRSearch.cfm?fr=172.804> (accessed 7.25.13).
- Chatjigakis, A., Pappas, C., N.Proxenia, O.Kalantzi, P.Rodis, Polissiou, M., 1998. FT-IR spectroscopic determination of the degree of esterification of cell wall pectins from stored peaches and correlation to textural changes. *Carbohydr. Polym.* 37, 395–408.
- Christgau, S., Kofod, L.V., Halkier, T., Andersen, L.N., Hockauf, M., Dorreich, K., Dalb?ge, H., Kauppinen, S., 1996. Pectin methyl esterase from *Aspergillus aculeatus*: expression cloning in yeast and characterization of the recombinant enzyme. *Biochem. J.* 319, 705–712.
- Clary, J.J., 2013. *The Toxicology of Methanol*. John Wiley & Sons.
- Couderc, R., Baratti, J., 1980. Oxidation of Methanol by the Yeast, *Pichia pastoris*. Purification and Properties of the Alcohol Oxidase. *Agric. Biol. Chem.* 44, 2279–2289.
- Coultate, T.P., 1996. Chapter 7 Flavours, in: *Food, the Chemistry of Its Components*. Royal Society of Chemistry.
- Darwish, I.A., Khedr, A.S., Askal, H.F., Mahmoud, R.M., 2005. Simple fluorimetric method for determination of certain antiviral drugs via their oxidation with cerium (IV). *Farm. Soc. Chim. Ital.* 1989 60, 555–562.
- De María, C.G., Manzano, T., Duarte, R., Alonso, A., 1995. Selective flow-injection determination of methanol using immobilized enzyme reactors. *Anal. Chim. Acta* 309, 241–250.
- Denniston, K.J., Topping, J.J., Caret, R.L., 2004. Chapter 15 Carboxylic acids and carboxylic acid derivatives, in: *General, Organic, and Biochemistry*. McGraw-Hill, New York, NY, USA, pp. 433–441.
- Dische, Z., 1947. A New Specific Color Reaction of Hexuronic Acids. *J. Biol. Chem.* 167, 189–198.
- Enzymatic Assay of Pectinase [WWW Document], n.d. Sigma-Aldrich. URL <http://www.sigmaaldrich.com/technical-documents/protocols/biology/enzymatic-assay-of-pectinase.html> (accessed 9.28.13).
- Eriksen, S.P., Kulkarni, A.B., 1963. Methanol in normal human breath. *Science* 141, 639–640.
- European Parliament and Council Directive 94/35/EC of 30 June 1994 on sweeteners for use in foodstuffs. [WWW Document], 1994. URL <http://eur-lex.europa.eu/LexUriServ/LexUriServ.do?uri=CELEX:31994L0035:EN:HTML> (accessed 7.25.13).

- Filisetti-Cozzi, T.M.C.C., Carpita, N.C., 1991. Measurement of uronic acids without interference from neutral sugars. *Anal. Biochem.* 197, 157–162.
- Food and Drug Administration, 1994. Food additives permitted for direct addition to food for human consumption; dimethyl dicarbonate [WWW Document]. URL <http://www.gpo.gov/fdsys/pkg/FR-1994-02-04/html/94-2474.htm> (accessed 7.10.13).
- Förster, E., Silva, M., Otto, M., Pérez-Bendito, D., 1993. Enzymatic determination of alcohol mixtures at the nanogram level by the stopped-flow technique. *Anal. Chim. Acta* 274, 109–116.
- Forster, H., 1988. Pectinesterase from *Phytophthora infestans*. *Methods Enzymol* 161, 355–357.
- Fries, M., Ihrig, J., Brocklehurst, K., Shevchik, V.E., Pickersgill, R.W., 2007. Molecular basis of the activity of the phytopathogen pectin methylesterase. *EMBO J.* 26, 3879–3887.
- Georgiou, C.A., International Fertiliser Society, Dahlia Greidinger Symposium, 2003. Developments in monitoring methods for nutrient solutions. International Fertiliser Society.
- Grsic-Rausch, S., Rausch, T., 2004. A coupled spectrophotometric enzyme assay for the determination of pectin methylesterase activity and its inhibition by proteinaceous inhibitors. *Anal. Biochem.* 333, 14–18.
- Guan, J., Michaelidou, T.A., Campomanes, M.J.P., Shetty, A., Hoang, T., 2011. Enhanced release of lipophilic ingredients from chewing gum with hydrocolloids. Patent number: WO2011163152 A1.
- Gummadi, S.N., Manoj, N., Kumar, D.S., 2007. Structural and Biochemical Properties of Pectinases, in: Polaina, J., MacCabe, A.P. (Eds.), *Industrial Enzymes*. Springer Netherlands, pp. 99–115.
- Hagerman, A.E., Austin, P.J., 1986. Continuous spectrophotometric assay for plant pectin methyl esterase. *J. Agric. Food Chem.* 34, 440–444.
- Hannemann, M., Antufjew, A., Borgmann, K., Hempel, F., Ittermann, T., Welzel, S., Weltmann, K.D., Völzke, H., Röpcke, J., 2011. Influence of age and sex in exhaled breath samples investigated by means of infrared laser absorption spectroscopy. *J. Breath Res.* 5.
- Hopkins, T.R., Muller, F., 1987. Biochemistry of Alcohol Oxidase, in: Verseveld, H.W. van, Duine, J.A. (Eds.), *Microbial Growth on C1 Compounds*. Springer Netherlands, pp. 150–157.
- Ibarz, A., Pagán, A., Tribaldo, F., Pagán, J., 2006. Improvement in the measurement of spectrophotometric data in the m-hydroxydiphenyl pectin determination methods. *Food Control* 17, 890–893.

- Isbell, H.S., Holt, N.B., 1945. Oxidation of galacturonic acid and of 5-keto-gluconic acid in alkaline solution. *J. Res. Natl. Bur. Stand.* 35, 433–438.
- IUPAC-IUB Commission on Biochemical Nomenclature, 1976. Nomenclature of Lipids [WWW Document]. URL <http://www.chem.qmul.ac.uk/iupac/lipid/> (accessed 7.8.13).
- Kayamori, Y., Katayama, Y., Urata, T., 2000. Nonenzymatic elimination of ascorbic acid in clinical samples. *Clin. Biochem.* 33, 25–29.
- Klavons, J.A., Bennett, R.D., 1986. Determination of methanol using alcohol oxidase and its application to methyl ester content of pectins. *J. Agric. Food Chem.* 34, 597–599.
- Larsson, B.T., 1965. Gas chromatography of organic volatiles in human breath and saliva. *Acta Chem. Scand.* 19, 159–164.
- Lee, E.W., Terzo, T.S., D'Arcy, J.B., Gross, K.B., Schreck, R.M., 1992. Lack of blood formate accumulation in humans following exposure to methanol vapor at the current permissible exposure limit of 200 ppm. *Am. Ind. Hyg. Assoc. J.* 53, 99–104.
- Lim, H.-S., Park, S.-K., Kwak, I.-S., Kim, H.-I., Sung, J.-H., Jang, S.-J., Byun, M.-Y., Kim, S.-H., 2013. HPLC-MS/MS analysis of 9 artificial sweeteners in imported foods. *Food Sci. Biotechnol.* 22, 233–240.
- Liu, L., Fishman, M.L., Hicks, K.B., 2007. Pectin in controlled drug delivery – a review. *Cellulose* 14, 15–24.
- Lodish, H., Berk, A., Zipursky, S.L., Matsudaira, P., Baltimore, D., Darnell, J., 2000. Structure of Nucleic Acids [WWW Document]. URL <http://www.ncbi.nlm.nih.gov/books/NBK21514/> (accessed 7.8.13).
- Logan, B.K., Distefano, S., 1998. Ethanol content of various foods and soft drinks and their potential for interference with a breath-alcohol test. *J. Anal. Toxicol.* 22, 181–183.
- Lund, E.D., Kirkland, C.L., Shaw, P.E., 1981. Methanol, ethanol, and acetaldehyde contents of citrus products. *J. Agric. Food Chem.* 29, 361–366.
- Mac Namara, K., Leardi, R., Sabuneti, A., 2005. Fast GC analysis of major volatile compounds in distilled alcoholic beverages: Optimisation of injection and chromatographic conditions. *Anal. Chim. Acta* 542, 260–267.
- Maldonado, M.C., de Saad, A.M.S., Callieri, D., 1994. Purification and characterization of pectinesterase produced by a strain of *Aspergillus niger*. *Curr. Microbiol.* 28, 193–196.
- Mangos, T.J., Haas, M.J., 1996. Enzymatic Determination of Methanol with Alcohol Oxidase, Peroxidase, and the Chromogen 2,2'-Azinobis(3-ethylbenzthiazoline-6-sulfonic acid) and Its Application to the Determination of the Methyl Ester Content of Pectins. *J. Agric. Food Chem.* 44, 2977–2981.

- Mansour, F.R., Danielson, N.D., 2012. Reverse flow-injection analysis. *TrAC - Trends Anal. Chem.* 40, 1–14.
- McNaught, A.D., Wilkinson, A., 1997. *Compendium of Chemical Terminology*, 2nd ed. (the “Gold Book”). ed. Blackwell Scientific Publications, Oxford.
- Moaleş, D., Şpac, A.F., Dorneanu, V., Butnaru, E., 2011. Validation of a gas chromatographic method for methanol determination. *Farmacia* 59, 70–76.
- Mohnen, D., 2008. Pectin structure and biosynthesis. *Curr. Opin. Plant Biol.* 11, 266–277.
- Moon, B.-U., De Vries, M.G., Westerink, B.H.C., Verpoorte, E., 2012. Development and characterization of a microfluidic glucose sensing system based on an enzymatic microreactor and chemiluminescence detection. *Sci. China Chem.* 55, 515–523.
- Morris, G.A., Kök, M.S., Harding, S.E., Adams, G.G., 2010. Polysaccharide drug delivery systems based on pectin and chitosan. *Biotechnol. Genet. Eng. Rev.* 27, 257–283.
- Osterloh, J.D., D’Alessandro, A., Chuwers, P., Mogadeddi, H., Kelly, T.J., 1996. Serum concentrations of methanol after inhalation at 200 ppm. *J. Occup. Environ. Med.* 38, 571–576.
- Pelloux, J., Rustérucci, C., Mellerowicz, E.J., 2007. New insights into pectin methyltransferase structure and function. *Trends Plant Sci.* 12, 267–277.
- Regulation (EC) No 1332/2008 of the European Parliament and of the Council of 16 December 2008 on food enzymes and amending Council Directive 83/417/EEC, Council Regulation (EC) No 1493/1999, Directive 2000/13/EC, Council Directive 2001/112/EC and Regulation (EC) No 258/9 [WWW Document], 2008. URL <http://eur-lex.europa.eu/LexUriServ/LexUriServ.do?uri=CELEX:32008R1332:EN:NOT> (accessed 9.25.13).
- Regulation (EC) No 1334/2008 of the European Parliament and of the Council of 16 December 2008 on flavourings and certain food ingredients with flavouring properties for use in and on foods and amending Council Regulation (EEC) No 1601/91, Regulations (EC) No 2232/96 and (EC) No 110/2008 and Directive 2000/13/EC. [WWW Document], 2008. . Off. J. 354 31122008 P 0034 - 0050. URL <http://eur-lex.europa.eu/LexUriServ/LexUriServ.do?uri=OJ:L:2008:354:0034:01:EN:HTML> (accessed 7.22.13).
- Regulation (EC) No 178/2002 of the European Parliament and of the Council of 28 January 2002 laying down the general principles and requirements of food law, establishing the European Food Safety Authority and laying down procedures in matters of food safety. [WWW Document], 2002. . Off. J. 031 01022002 P 0001 - 0024. URL [http://eur-](http://eur-lex.europa.eu/LexUriServ/LexUriServ.do?uri=CELEX:32002R0178:EN:NOT)

lex.europa.eu/LexUriServ/LexUriServ.do?uri=CELEX:32002R0178:EN:HTML (accessed 7.22.13).

- Ridley, B.L., O'Neill, M.A., Mohnen, D., 2001. Pectins: structure, biosynthesis, and oligogalacturonide-related signaling. *Phytochemistry* 57, 929–967.
- Ruzicka, J., 1988. *Flow Injection Analysis*. John Wiley & Sons.
- Ruzicka, J., Hansen, E.H., 1975. Flow injection analyses: Part I. A new concept of fast continuous flow analysis. *Anal. Chim. Acta* 78, 145–157.
- Savary, B.J., Nuñez, A., 2003. Gas chromatography-mass spectrometry method for determining the methanol and acetic acid contents of pectin using headspace solid-phase microextraction and stable isotope dilution. *J. Chromatogr. A* 1017, 151–159.
- Schomberg, D., Salzmann, M., Stephan, D., 1993. EC1.11.1.7, in: *Enzyme Handbook* 7. pp. 1–6.
- Sedivec, V., Mráz, M., Flek, J., 1981. Biological monitoring of persons exposed to methanol vapours. *Int. Arch. Occup. Environ. Health* 48, 257–271.
- Sekine, Y., Suzuki, M., Takeuchi, T., Tamiya, E., Karube, I., 1993. Selective flow-injection determination of methanol in the presence of ethanol based on a multi-enzyme system with chemiluminescence detection. *Anal. Chim. Acta* 280, 179–184.
- Sharma, V.K., Jadhav, R.K., Rao, G.J., Saraf, A.K., Chandra, H., 1991. High performance liquid chromatographic determination of alcohols with reference to body distribution of methanol. *Forensic Sci. Int.* 50, 255–261.
- Shiga, M., Miyazono, Y., Ishiyama, M., Sasamoto, K., Ueno, K., 1997. 4-Hydroxy-2,2,6,6-tetramethyl-1-piperidinyloxy Free Radical as a Novel Ascorbic Acid Quencher. *Anal. Commun.* 34, 115–117.
- Sieiro, C., Garcia-Fraga, B., Lopez-Seijas, J., da Silva, A.F., G., T., 2012. Microbial Pectic Enzymes in the Food and Wine Industry, in: Valdez, B. (Ed.), *Food Industrial Processes - Methods and Equipment*. InTech.
- Significant Amendments to the FD&C Act - Food Quality Protection Act of 1996 [WWW Document], 1996. URL <http://www.fda.gov/RegulatoryInformation/Legislation/FederalFoodDrugandCosmeticActFDCAAct/SignificantAmendmentstotheFDCAAct/ucm148008.htm> (accessed 7.19.13).
- Skoog, D.A., Holler, F.J., Nieman, T.A., 1998. *Principles of instrumental analysis*. Saunders College Pub.
- Stojkovic, M., Mai, T.D., Hauser, P.C., 2013. Determination of artificial sweeteners by capillary electrophoresis with contactless conductivity detection optimized by hydrodynamic pumping. *Anal. Chim. Acta* 787, 254–259.

- Sunghongjeen, S., Sriamornsak, P., Pitaksuteepong, T., Somsiri, A., Puttipipatkachorn, S., 2004. Effect of degree of esterification of pectin and calcium amount on drug release from pectin-based matrix tablets. *AAPS PharmSciTech* 5.
- Tandel, K.R., 2011. Sugar substitutes: Health controversy over perceived benefits. *J. Pharmacol. Pharmacother.* 2, 236–243.
- Thibault, J.-F., Ralet, M.-C., 2001. Pectins, their Origin, Structure and Functions, in: McCleary, B.V., Prosky, L. (Eds.), *Advanced Dietary Fibre Technology*. Blackwell Science Ltd, pp. 369–378.
- Tóth, I.V., Segundo, M.A., Rangel, A.O.S.S., 2008. Chapter 18 Food, Beverages and Agricultural Applications, in: Spas D. Kolev and Ian D. Mckelvie (Ed.), *Comprehensive Analytical Chemistry*. Elsevier, pp. 513–558.
- Turak, F., Ozgur, M.U., 2013. Validated spectrophotometric methods for simultaneous determination of food colorants and sweeteners. *J. Chem.*
- Vasilarou, A.-M.G., Georgiou, C.A., 2000. Enzymatic Spectrophotometric Reaction Rate Determination of Glucose in Fruit Drinks and Carbonated Beverages: An Analytical Chemistry Laboratory Experiment for Food Science-Oriented Students. *J. Chem. Educ.* 77, 1327–1329.
- Vilariño, C., Del Giorgio, J.F., Hours, R.A., Cascone, O., 1993. Spectrophotometric Method for Fungal Pectinesterase Activity Determination. *LWT - Food Sci. Technol.* 26, 107–110.
- Vincken, J.-P., Schols, H.A., Oomen, R.J.F.J., McCann, M.C., Ulvskov, P., Voragen, A.G.J., Visser, R.G.F., 2003. If homogalacturonan were a side chain of rhamnogalacturonan I. Implications for cell wall architecture. *Plant Physiol.* 132, 1781–1789.
- Voragen, A.G.J., Schols, H.A., Pilnik, W., 1986. Determination of the degree of methylation and acetylation of pectins of H. P. L. C. *Food Hydrocoll.* 1, 65–70.
- Whitehouse, C.R., Boullata, J., McCauley, L.A., 2008. The potential toxicity of artificial sweeteners. *AAOHN J. Off. J. Am. Assoc. Occup. Health Nurses* 56, 251–259; quiz 260–261.
- Willats, W.G., Knox, J.P., Mikkelsen, J.D., 2006. Pectin: new insights into an old polymer are starting to gel. *Trends Food Sci. Technol.* 17, 97–104.
- Willats, W.G.T., McCartney, L., Mackie, W., Knox, J.P., 2001. Pectin: cell biology and prospects for functional analysis. *Plant Mol. Biol.* 47, 9–27.
- Worthington, Von (Ed.), 1993. Introduction to enzymes., in: *Worthington Enzyme Manual, Enzymes and Related Biochemicals*. WorthingtonBiochemical Corporation, New Jersey, U.S.A.



Yue, X.-F., Zhang, Z.-Q., 2007. Simultaneous determination of formaldehyde and methanol by flow-injection catalytic spectrophotometry. *J. Anal. Chem.* 62, 992–996.